

05

Klemmen

Forceps, Clamps, Clips

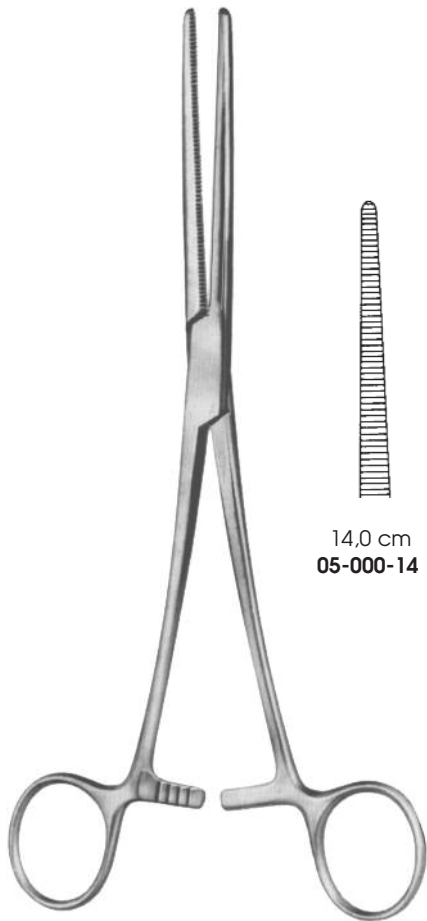

Rochester-Péan

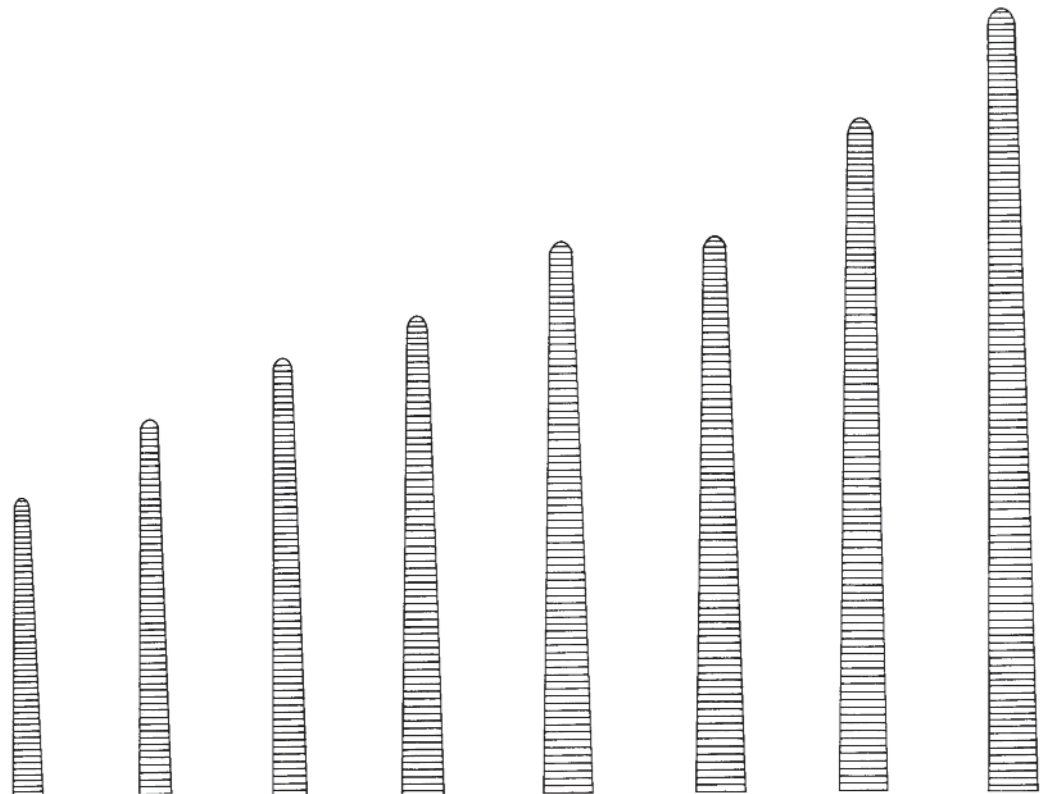

14,0 cm 05-000-14 16,0 cm 05-000-16 18,0 cm 05-000-18 20,0 cm 05-000-20 22,0 cm 05-000-22 24,0 cm 05-000-24 26,0 cm 05-000-26 30,0 cm 05-000-30

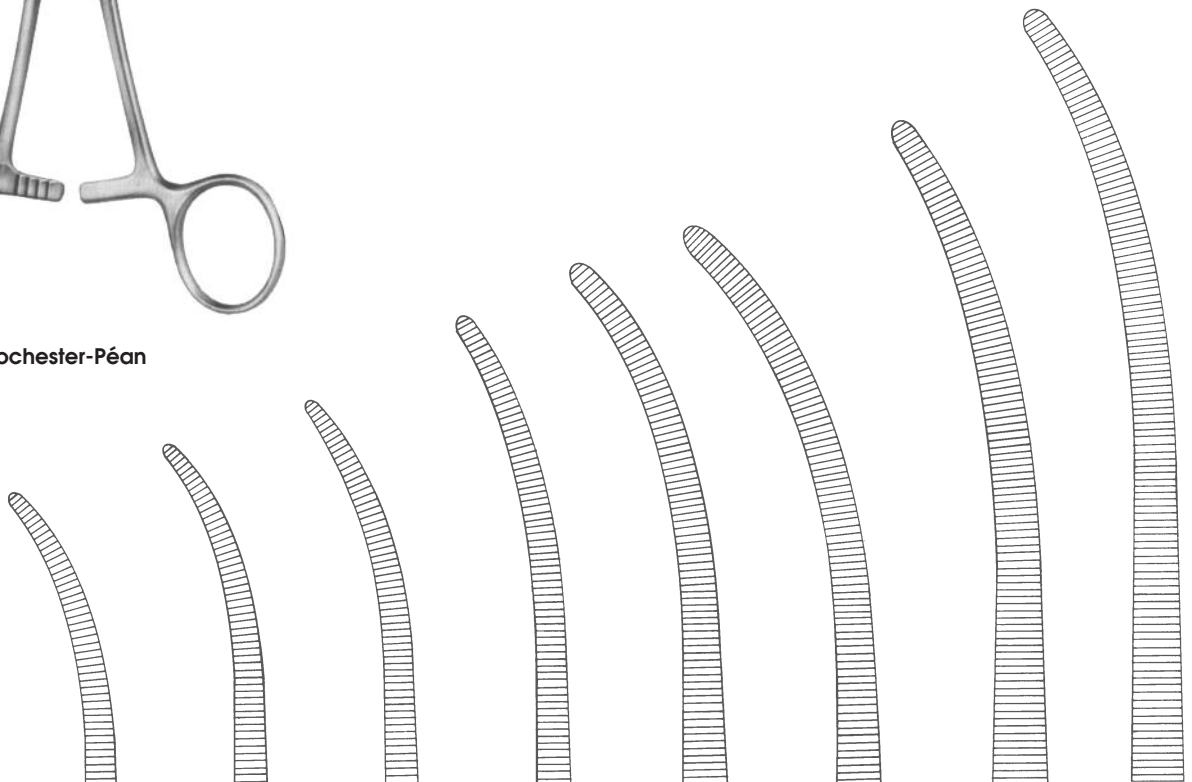

14,0 cm 05-001-14 16,0 cm 05-001-16 18,0 cm 05-001-18 20,0 cm 05-001-20 22,0 cm 05-001-22 24,0 cm 05-001-24 26,0 cm 05-001-26 30,0 cm 05-001-30



14,0 cm **05-004-14**
 16,0 cm **05-004-16**
 18,0 cm **05-004-18**

Péan-Nippon



14,0 cm **05-005-14**
 16,0 cm **05-005-16**
 18,0 cm **05-005-18**



13,0 cm **05-010-13**
 14,0 cm **05-010-14**
 16,0 cm **05-010-16**

Péan, grazil



13,0 cm **05-011-13**
 14,0 cm **05-011-14**
 16,0 cm **05-010-16**

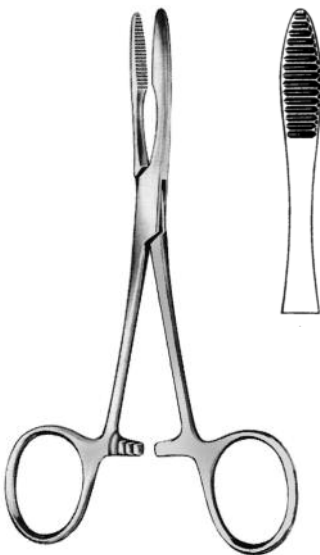

Péan
 12,0 cm **05-012-12**
 14,0 cm **05-012-14**
 16,0 cm **05-012-16**



13,0 cm **05-014-13**
 14,0 cm **05-014-14**
 15,0 cm **05-014-15**
 18,0 cm **05-014-18**
 20,0 cm **05-014-20**

Spencer-Wells



13,0 cm **05-015-13**
 14,0 cm **05-015-14**
 15,0 cm **05-015-15**
 18,0 cm **05-015-18**
 20,0 cm **05-015-20**

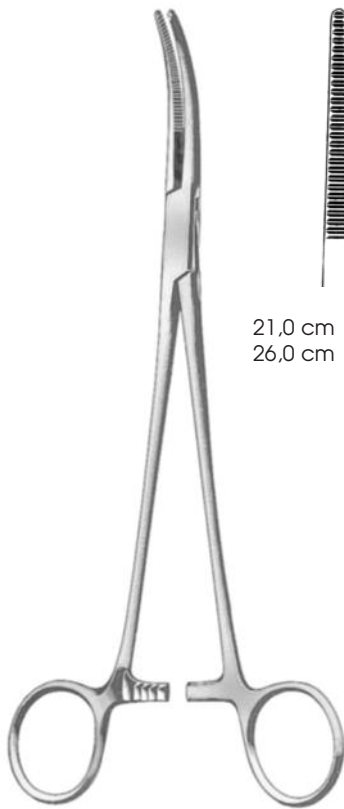

21,0 cm **05-018-21**
26,0 cm **05-018-26**



21,0 cm **05-019-21**
26,0 cm **05-019-26**



20,0 cm **05-020-20**
26,0 cm **05-020-26**

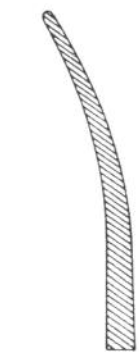

20,0 cm **05-021-20**
26,0 cm **05-021-26**

Toennis

Bengolea



20,0 cm **05-022-20**



20,0 cm **05-023-20**



20,0 cm **05-025-20**

Heiss

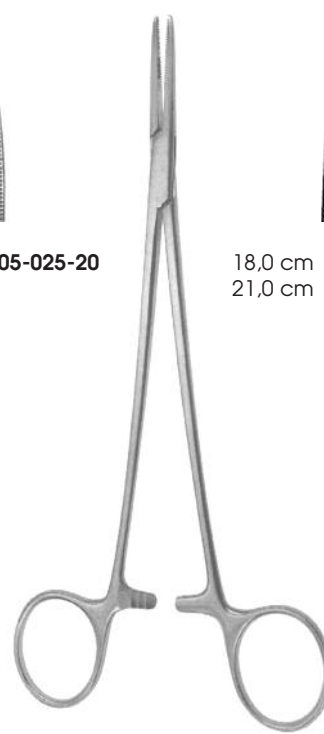

18,0 cm **05-026-18**
21,0 cm **05-026-21**



18,0 cm **05-027-18**
21,0 cm **05-027-21**

Halsted-Mosquito



18,0 cm **05-029-18**



19,0 cm **05-029-19**

Schnidt

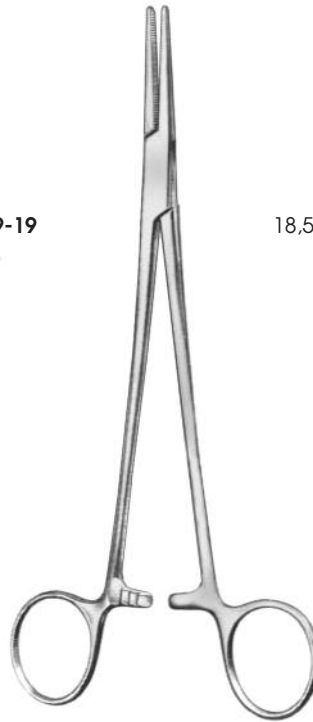

18,5 cm **05-030-18**



19,0 cm **05-031-19**

Adson



Mikro-Adson
 14,0 cm **05-033-14**

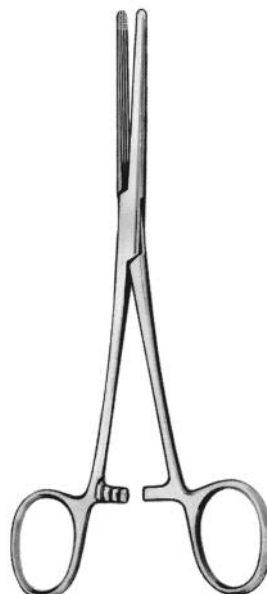

Rochester-Carmalt

16,0 cm
05-034-16



20,0 cm
05-034-20



16,0 cm
05-035-16

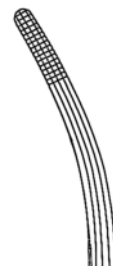

20,0 cm
05-035-20





Brainbridge

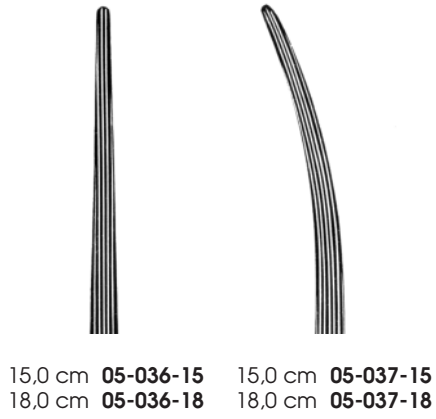

15,0 cm **05-036-15** 15,0 cm **05-037-15**
18,0 cm **05-036-18** 18,0 cm **05-037-18**



Crile-Rankin

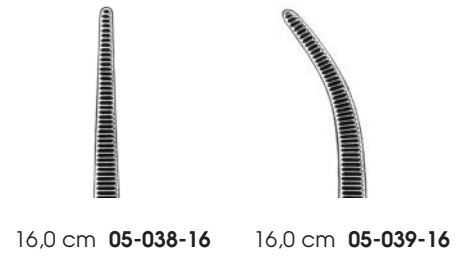

16,0 cm **05-038-16** 16,0 cm **05-039-16**



Kelly-Rankin
16,0 cm **05-042-16**



16,0 cm **05-043-16**



Dixon-Lovelace
15,0 cm **05-044-15**



Fuchsig
20,0 cm **05-045-20**





15,0 cm **05-046-15**

15,0 cm **05-047-15**

Leriche

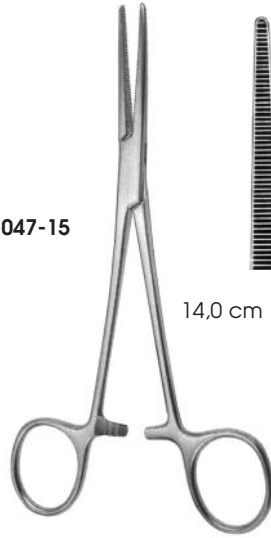

14,0 cm **05-048-14**

14,0 cm **05-049-14**

Crile

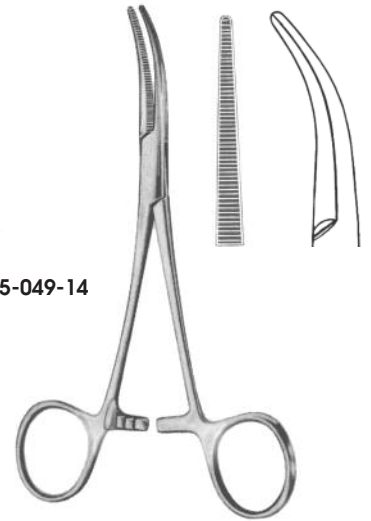

Dandy
 12,0 cm **05-051-12**
 14,0 cm **05-051-14**



14,0 cm **05-052-14**

14,0 cm **05-053-14**

Kelly



14,0 cm **05-054-14**

14,0 cm **05-055-14**

Providence-Hospital



Halsted-Mosquito

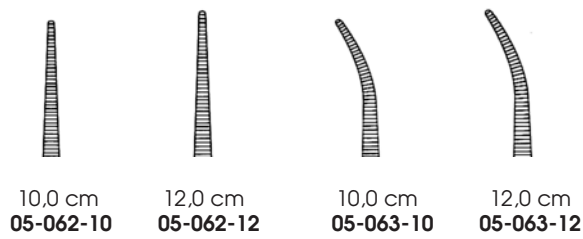
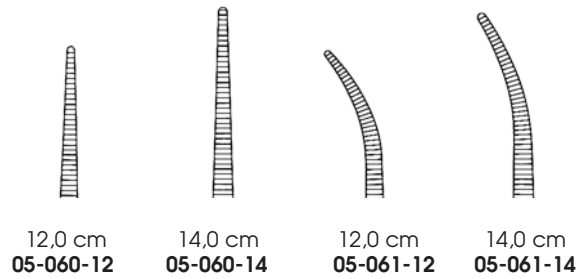

Mikro-Mosquito



Baby-Mosquito

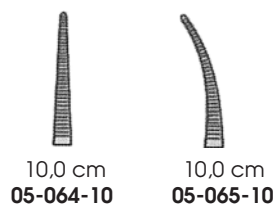

Krönlein
13,0 cm 05-072-13

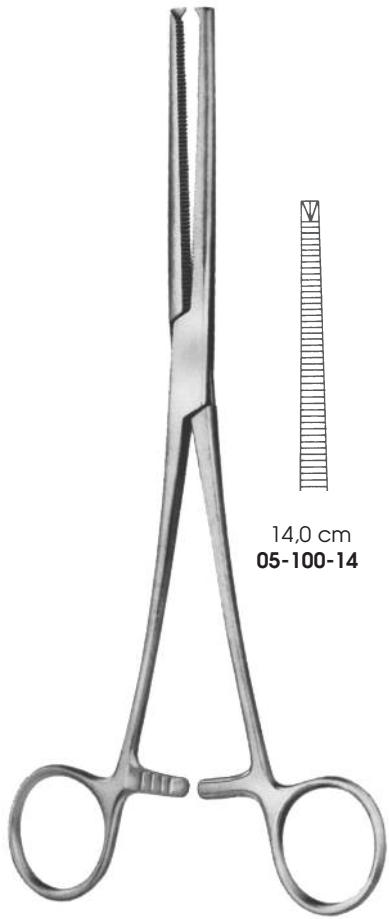

Ochsner-Kocher

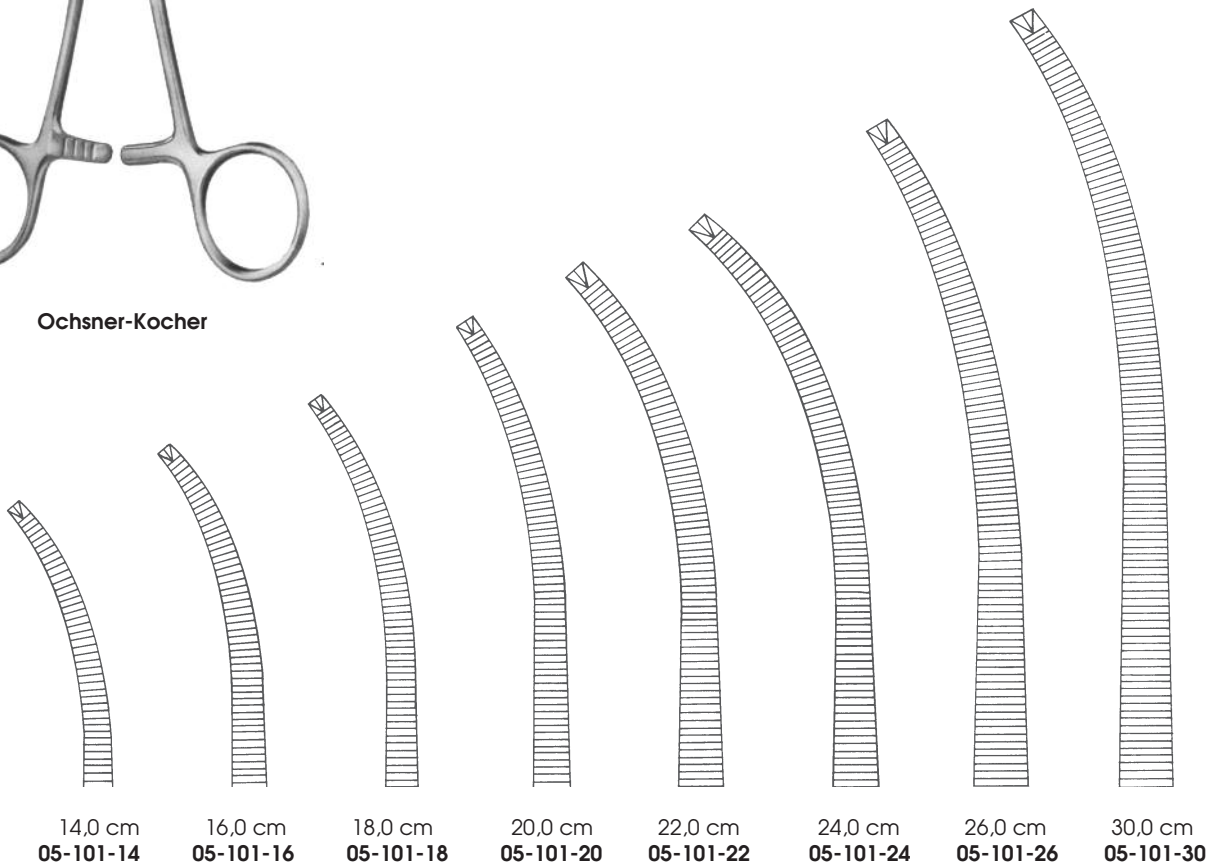
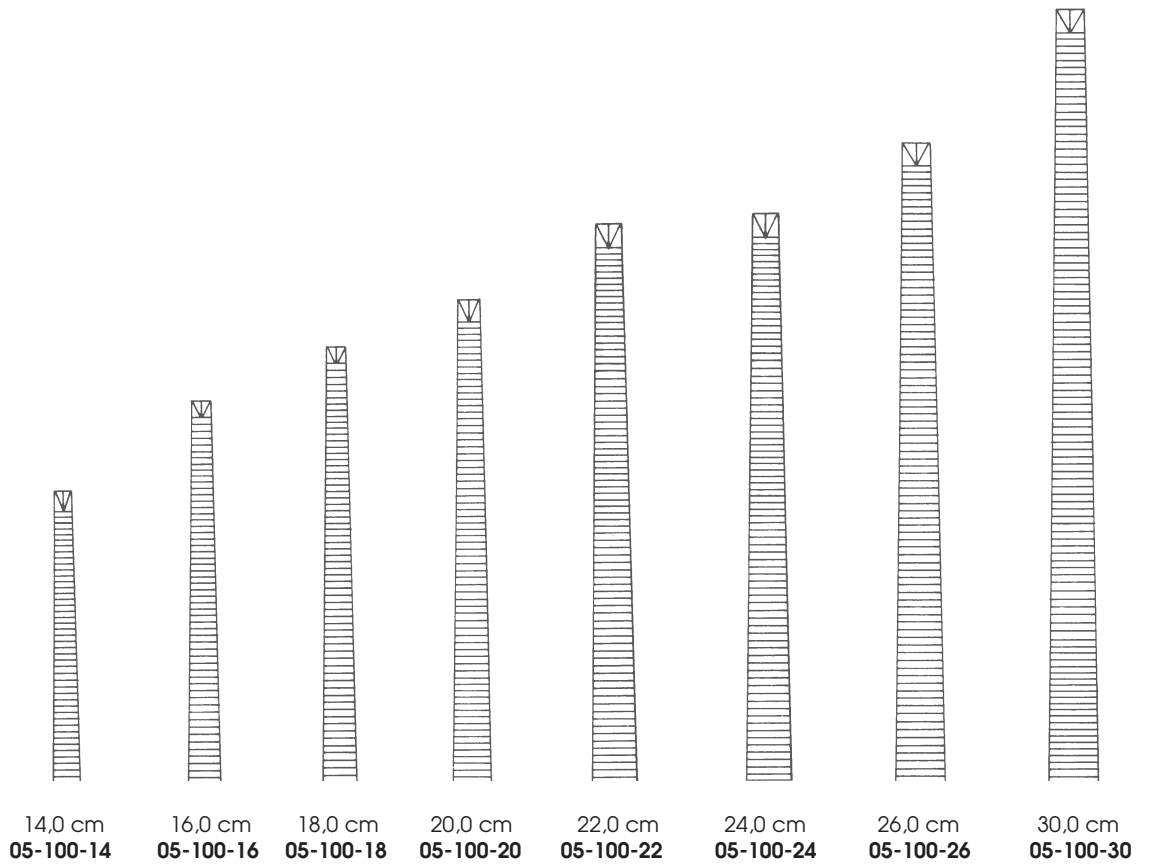

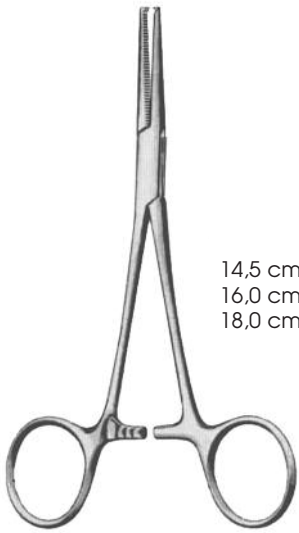

Kocher-Nippon

14,5 cm **05-104-14**
16,0 cm **05-104-16**
18,0 cm **05-104-18**



14,5 cm **05-105-14**
16,0 cm **05-105-16**
18,0 cm **05-105-18**



Kocher

13,0 cm **05-110-13**
14,0 cm **05-110-14**
16,0 cm **05-110-16**



13,0 cm **05-111-13**
14,0 cm **05-111-14**
16,0 cm **05-111-16**



Toennis

21,0 cm **05-112-21**
26,0 cm **05-112-26**



21,0 cm **05-113-21**
26,0 cm **05-113-26**

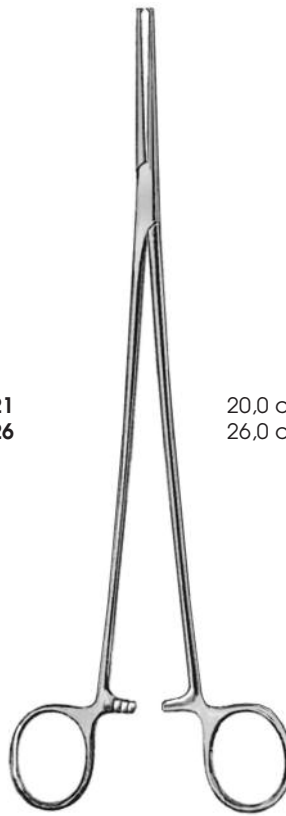

Bengolea

20,0 cm **05-120-20**
26,0 cm **05-120-26**



20,0 cm **05-121-20**
26,0 cm **05-121-26**

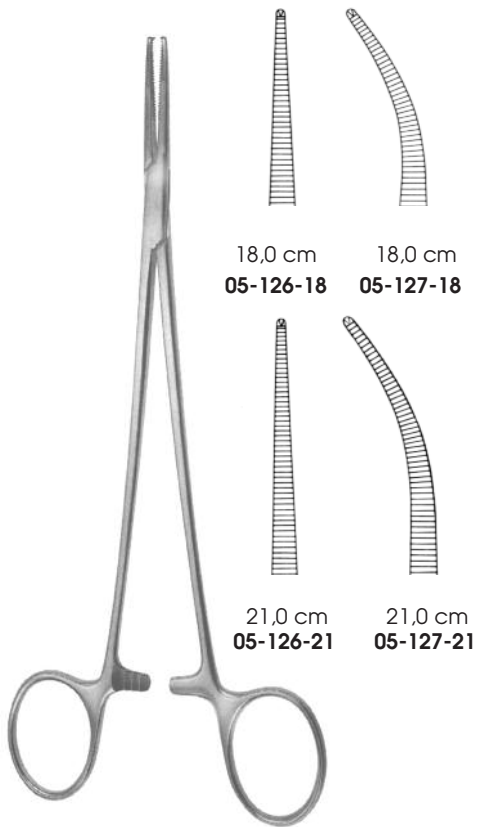

Halsted-Mosquito

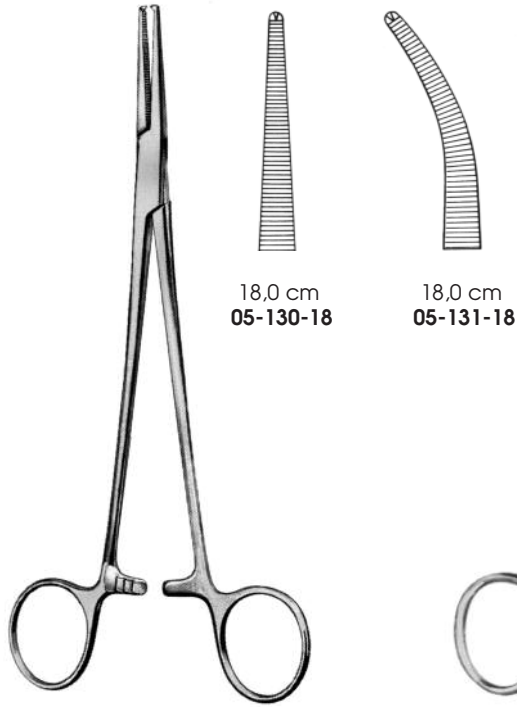

Adson

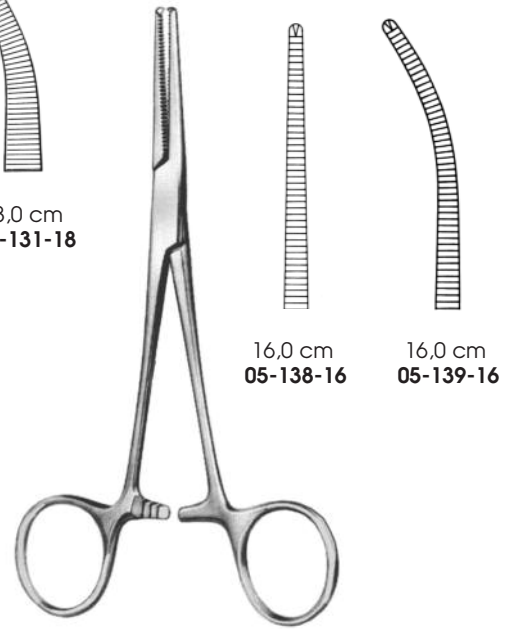

Crile-Rankin



Dixon-Lovelace

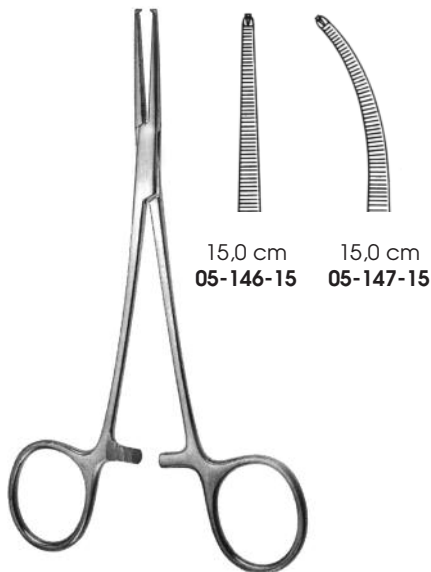

Leriche

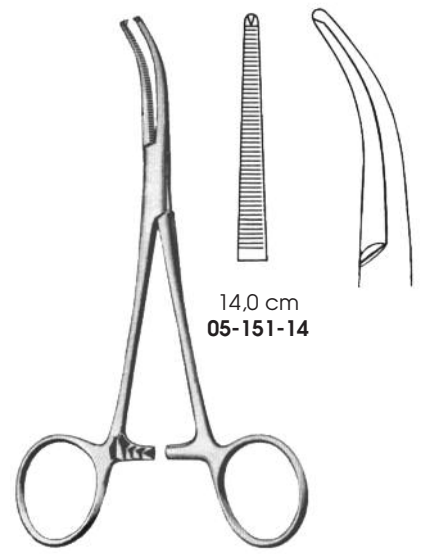

Dandy



Halsted-Mosquito

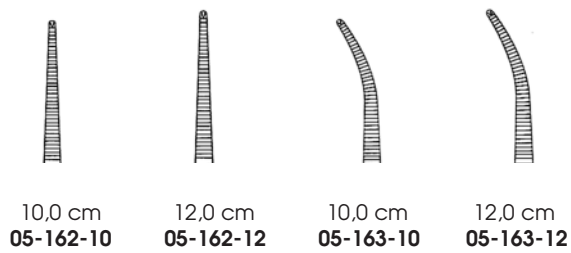
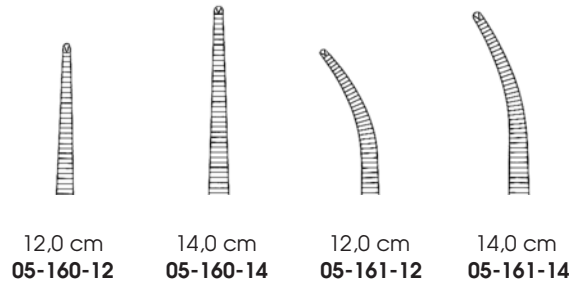

Mikro-Mosquito



Terrier
8,0 cm 05-166-08



Overholt-Geissendörfer

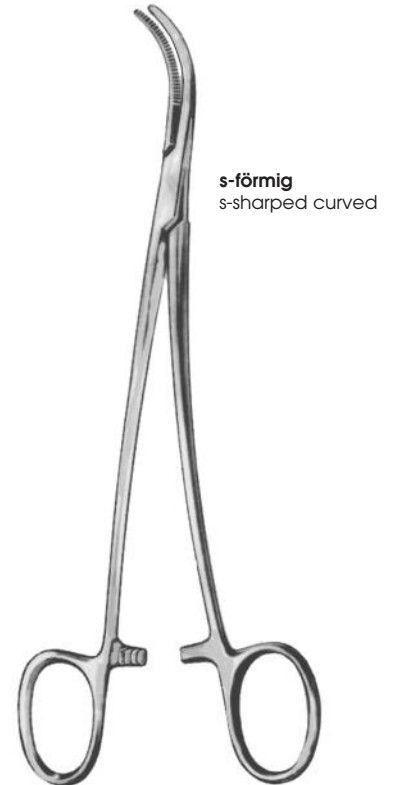
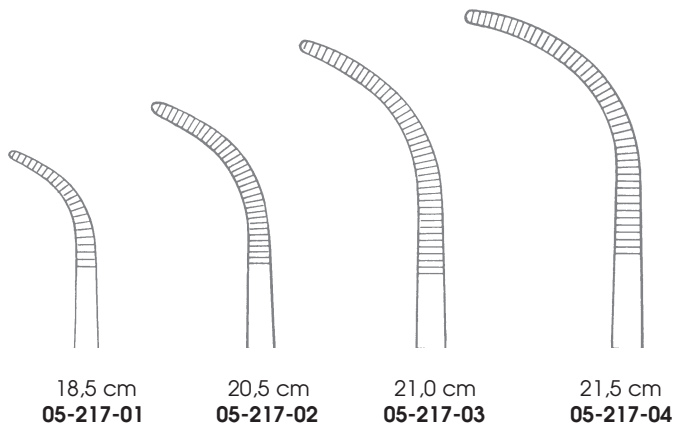
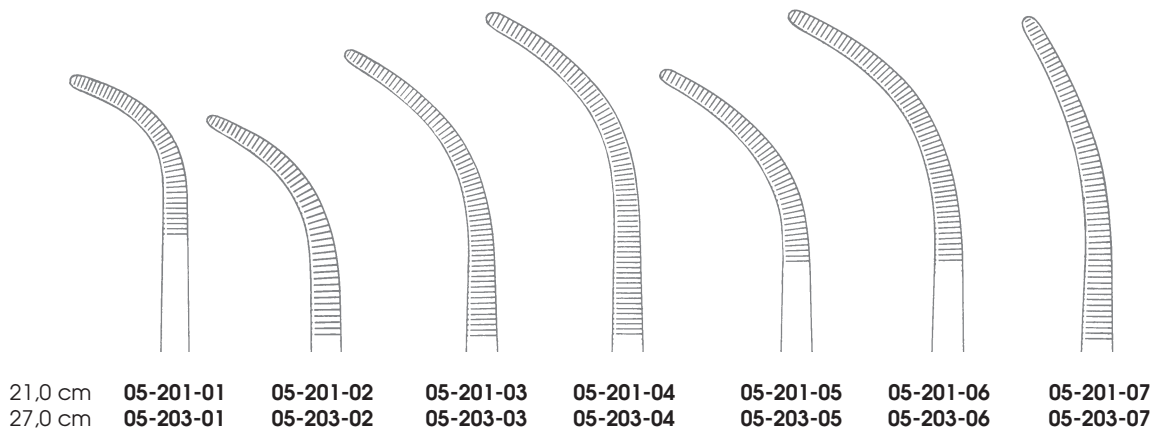

Overholt

s-förmig
 s-sharped curved



Zenker

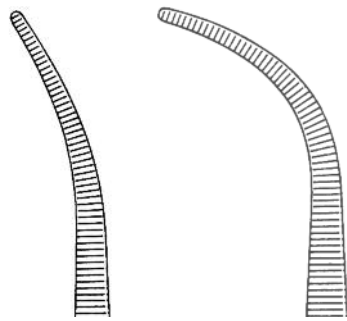

30,0 cm **05-225-30** 30,0 cm **05-231-30**



Lawrence

28,0 cm **05-233-28**

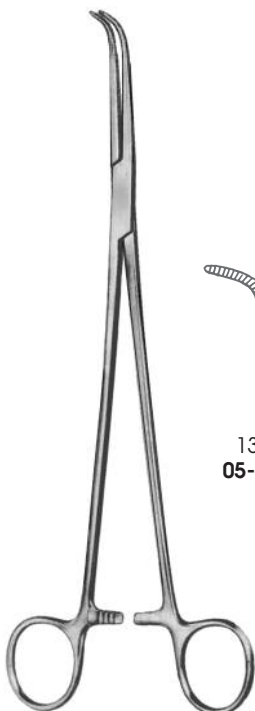

Gemini

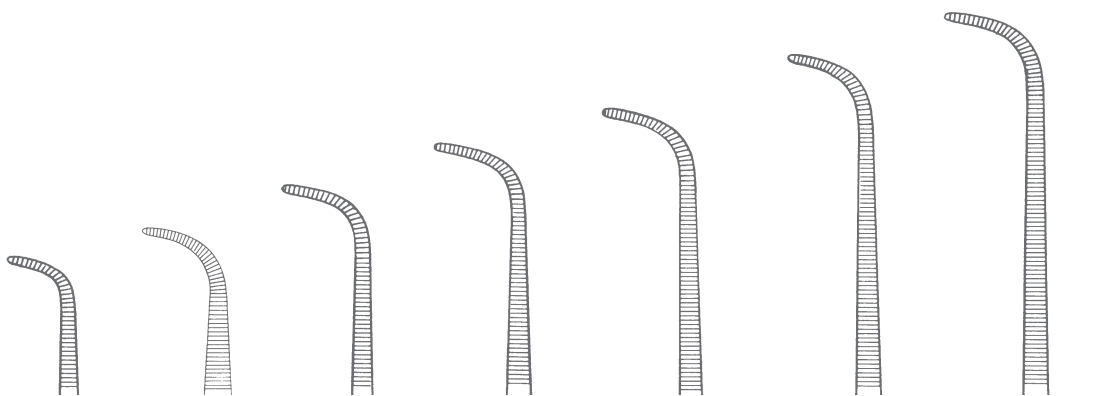

13,0 cm
05-237-13

16,0 cm
05-237-16

18,0 cm
05-237-18

20,0 cm
05-237-20

23,0 cm
05-237-23

25,0 cm
05-237-25

28,0 cm
05-237-28

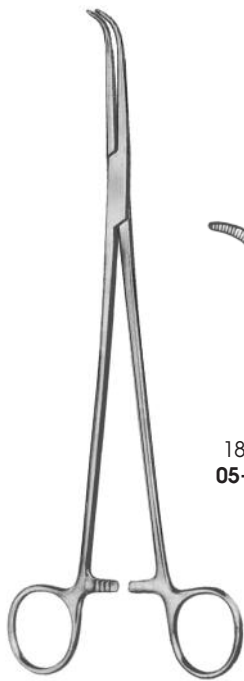

18,0 cm
 05-239-18

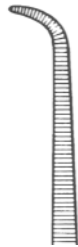

22,0 cm
 05-239-22

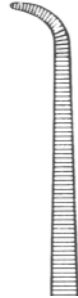

25,0 cm
 05-239-25

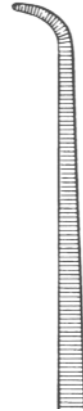

28,0 cm
 05-239-28

Mini-Gemini



Meeker
 18,0 cm 05-243-18
 28,0 cm 05-243-28

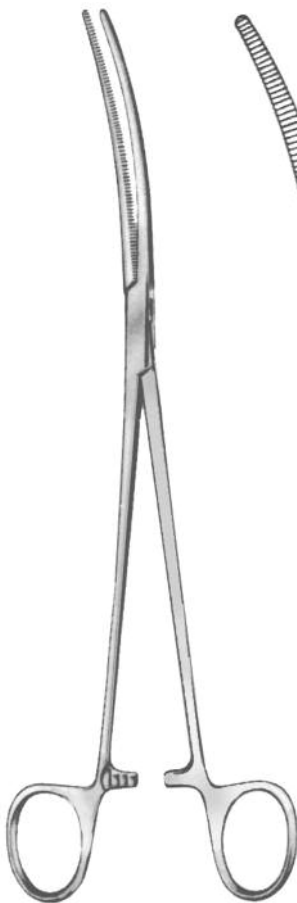

Crafoord
 18,0 cm 05-245-18
 24,0 cm 05-245-24

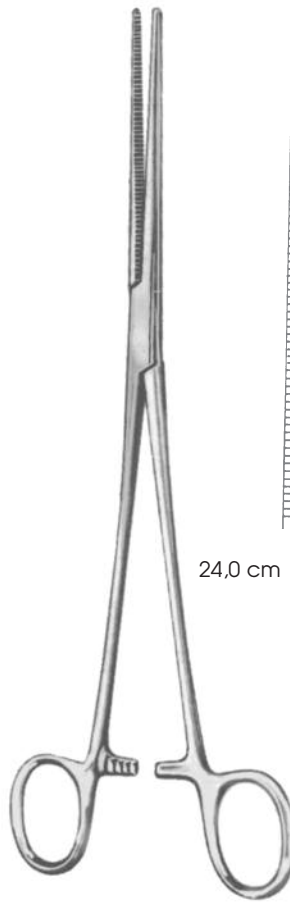

Sarot

24,0 cm 05-248-24 24,0 cm 05-249-24

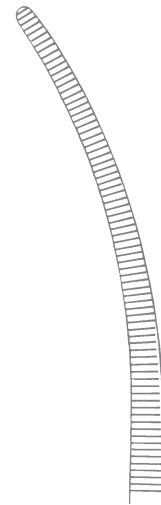

Arterienklemmen
Haemostatic Forceps

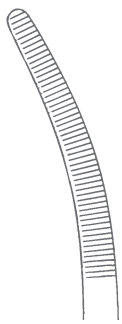

23,0 cm
05-251-23

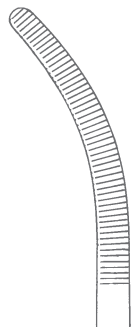

23,0 cm
05-252-23

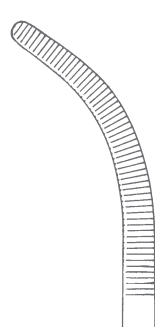

23,0 cm
05-253-23

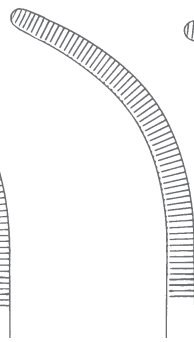

23,0 cm
05-255-23

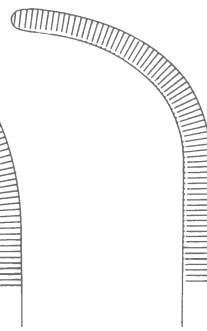

23,0 cm
05-257-23



Rumel



Mixer
23,0 cm 05-259-23



Overholt-Mixer
21,0 cm 05-261-21



Mixer
15,0 cm 05-263-15
19,0 cm 05-263-19

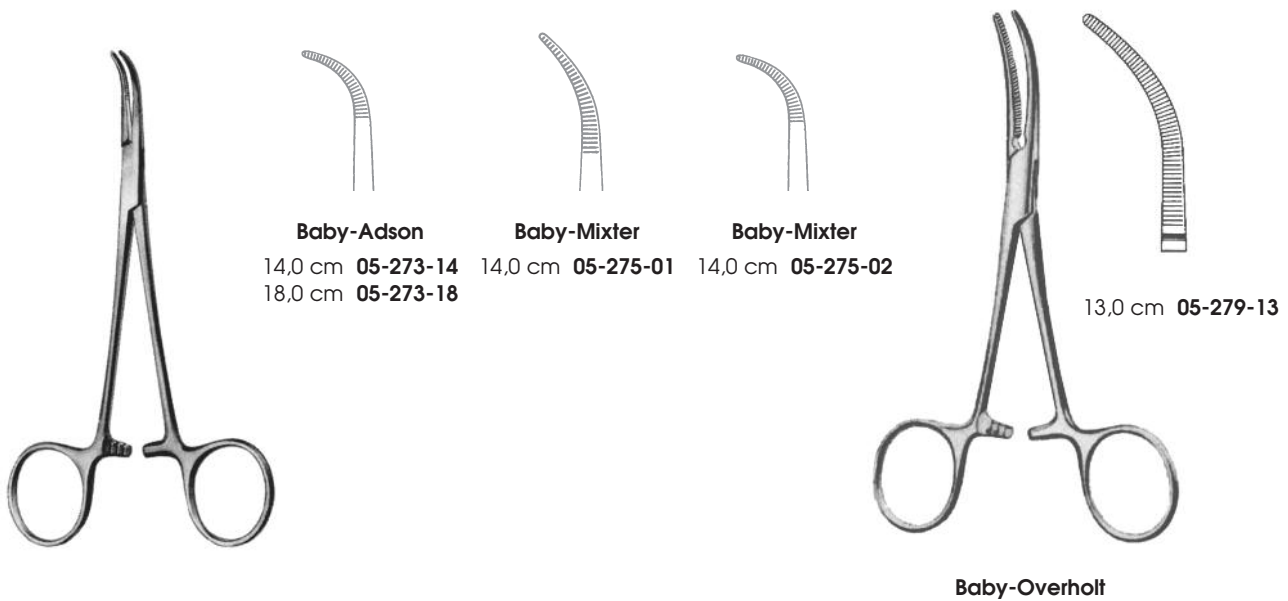
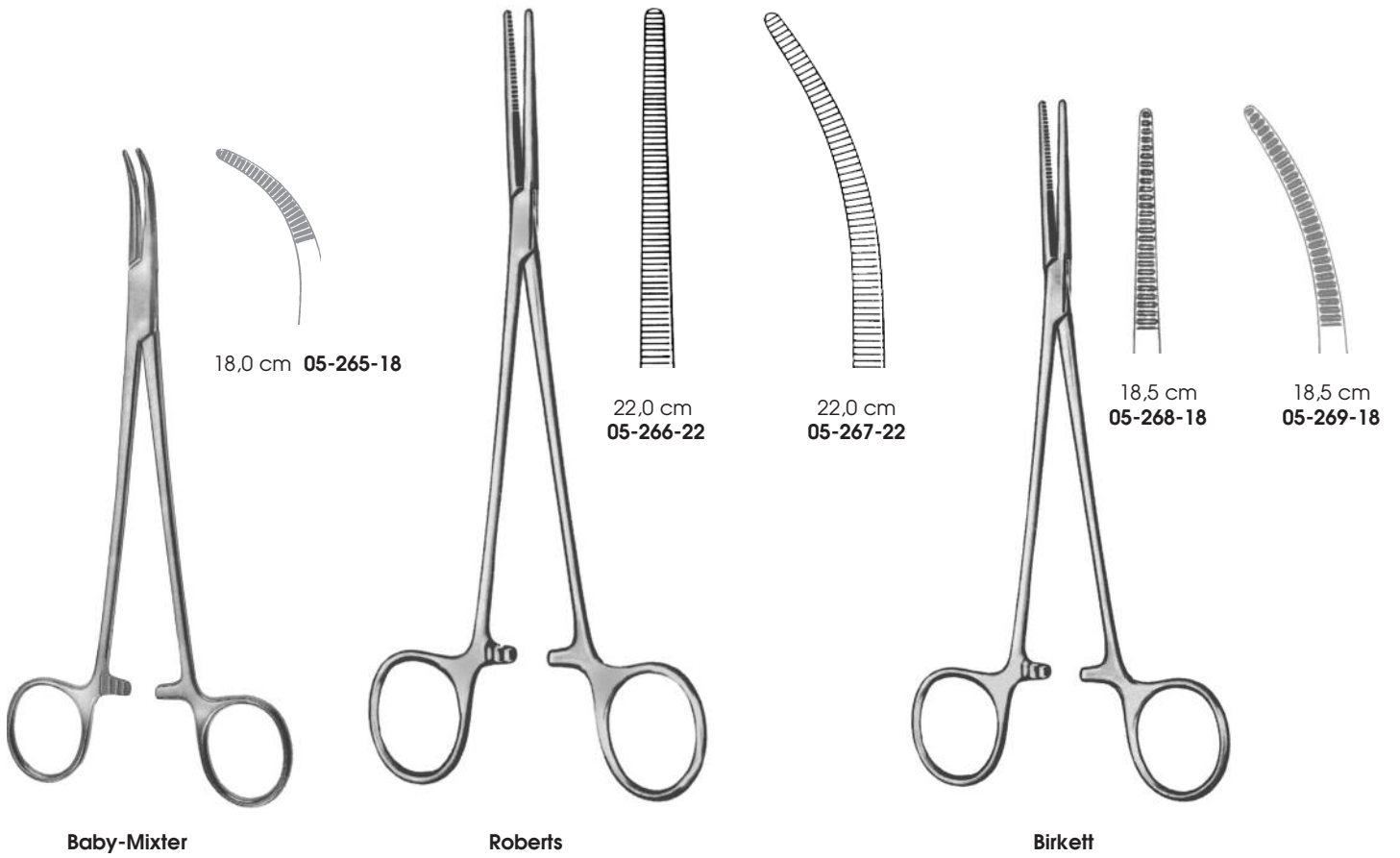



Kelly



19,0 cm
05-281-19



22,0 cm
05-281-22

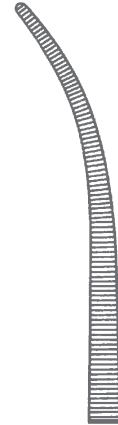

24,0 cm
05-281-24



19,0 cm
05-283-19



22,0 cm
05-283-22



24,0 cm
05-283-24

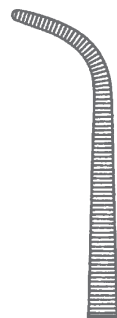

19,0 cm
05-285-19



22,0 cm
05-285-22

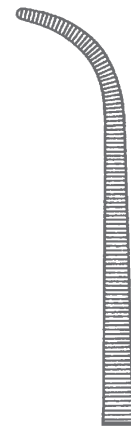

24,0 cm
05-285-24

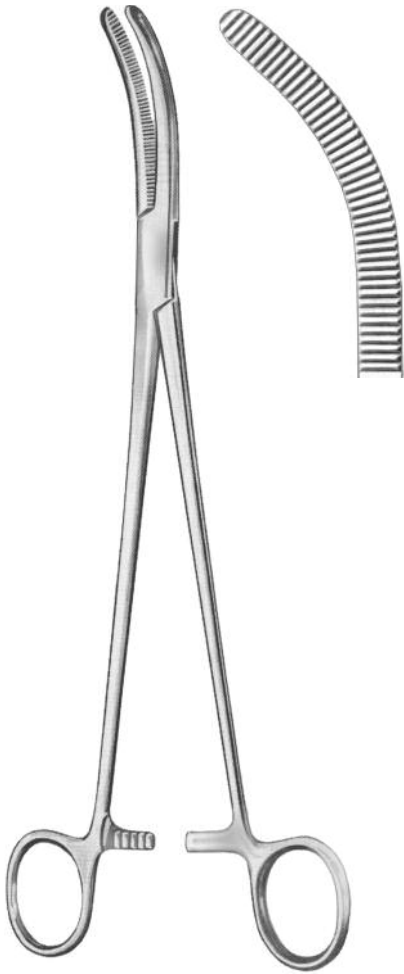

Wertheim
 25,0 cm 05-305-25



leicht gebogen
 slightly curved

stärker gebogen
 more curved

22,0 cm
 05-307-22

23,0 cm
 05-307-23

Wertheim

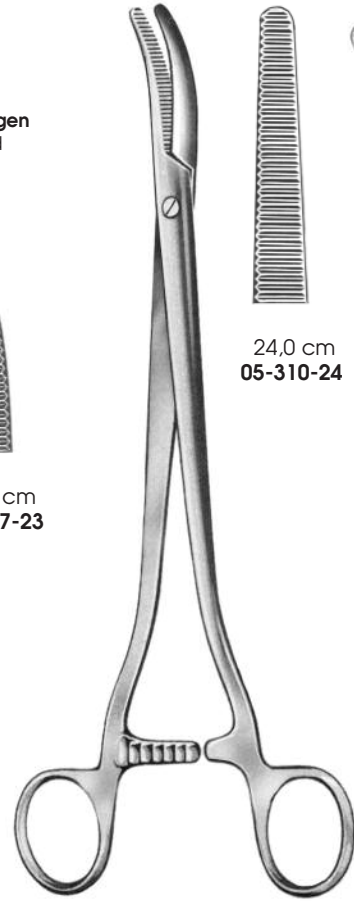

Segond-Landau

24,0 cm
 05-310-24

24,0 cm
 05-311-24



23,0 cm
 05-313-23

24,0 cm
 05-313-24



Moynihan

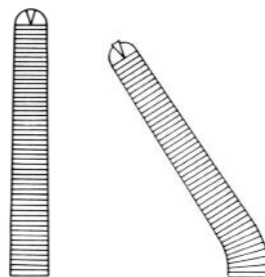

21,5 cm
 05-314-21

21,0 cm
 05-315-21

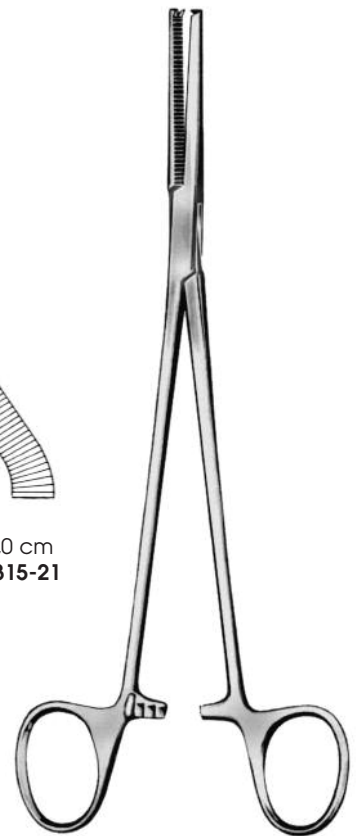

Phaneuf

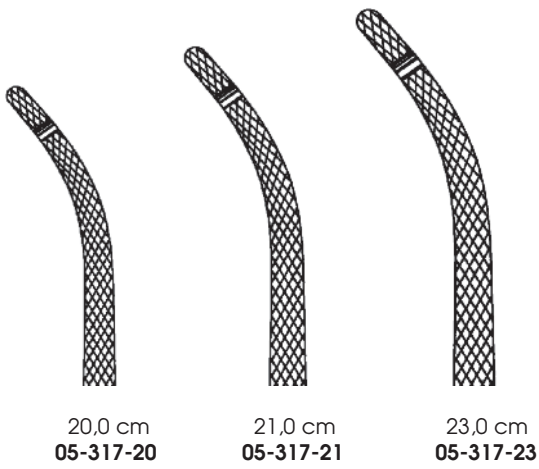

Heaney

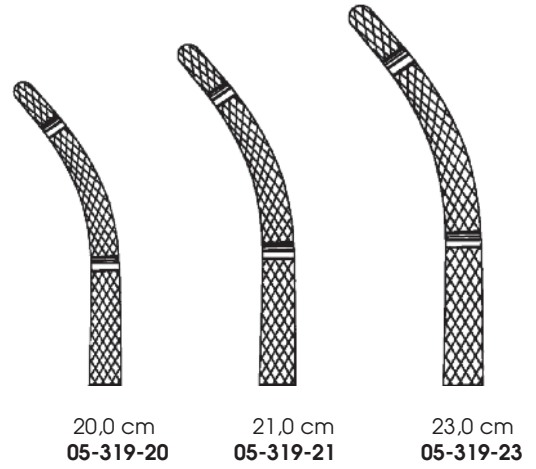

Rogers





Werheim
 21,0 cm 05-335-21

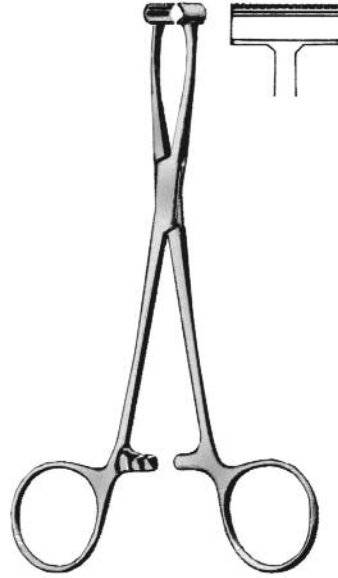

Pratt
 15,0 cm 05-338-15

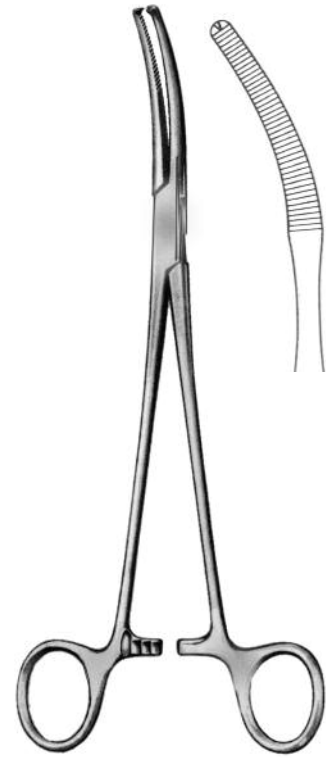

Mikulicz
 20,5 cm 05-339-20

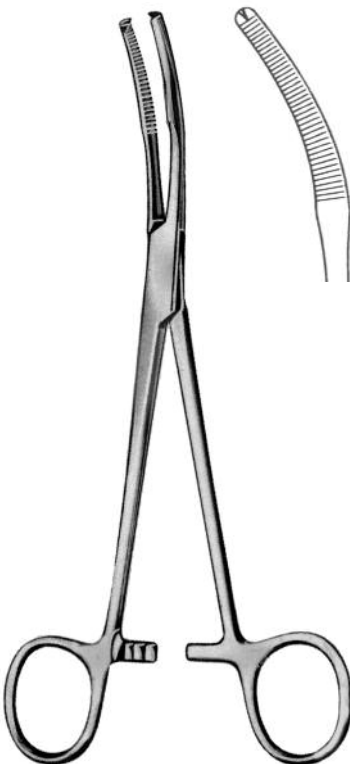

Mikulicz
 20,0 cm 05-341-20

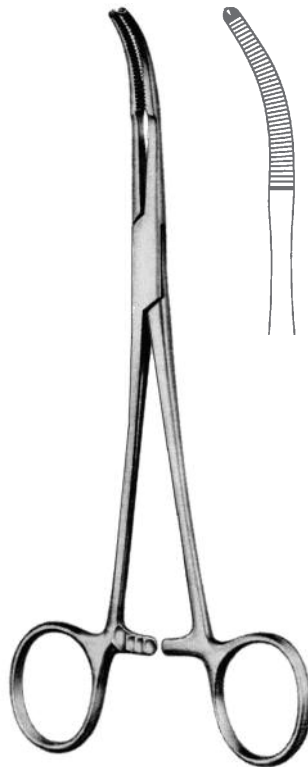

Baby-Mikulicz
 14,0 cm 05-343-14
 18,0 cm 05-343-18
 20,0 cm 05-343-20



Faure

05-345-19

05-345-20



22,0 cm
05-355-22

25,0 cm
05-355-25

28,0 cm
05-355-28

Mixer

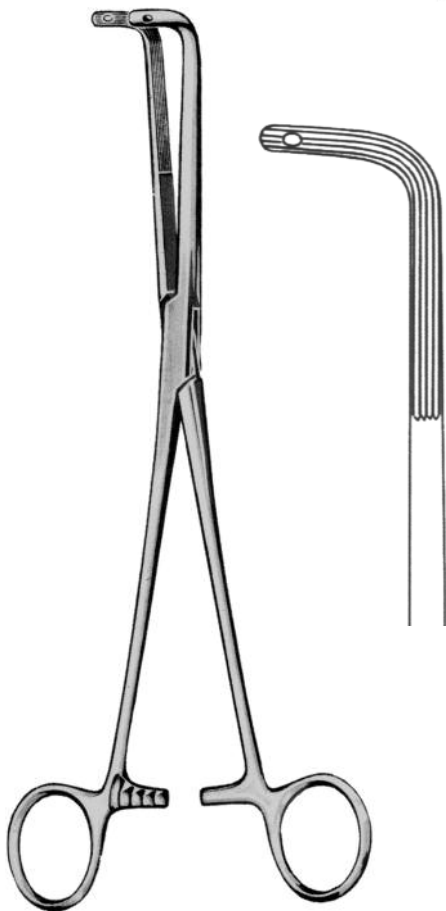

Finochietto
24,0 cm 05-357-24

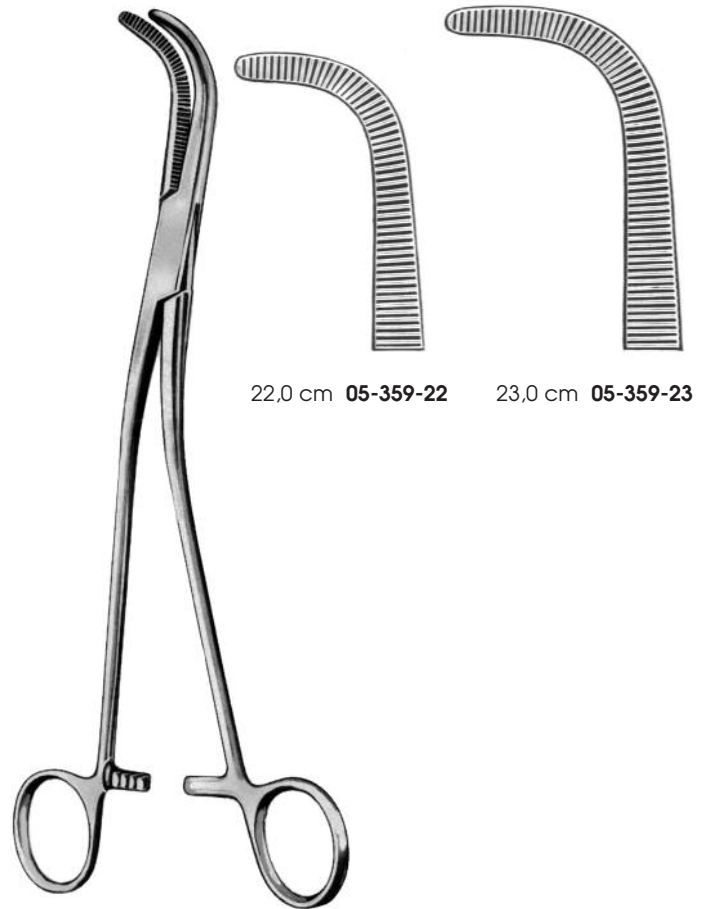

22,0 cm 05-359-22

23,0 cm 05-359-23

Gray

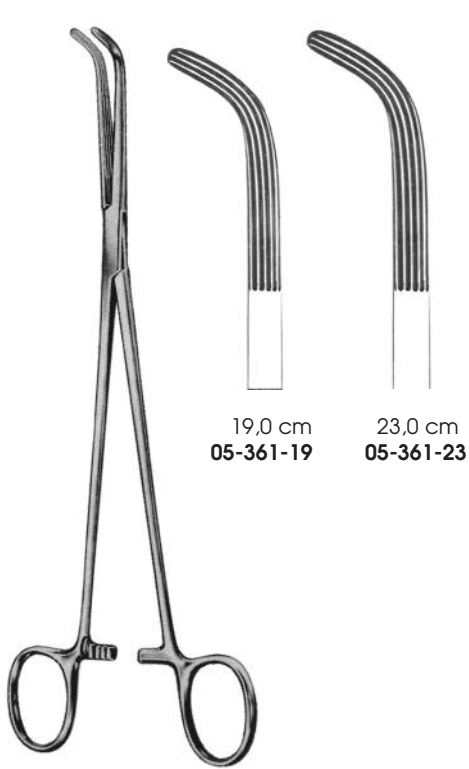

19,0 cm
 05-361-19

23,0 cm
 05-361-23

Lahey



Johns-Hopkins
 20,0 cm 05-363-20

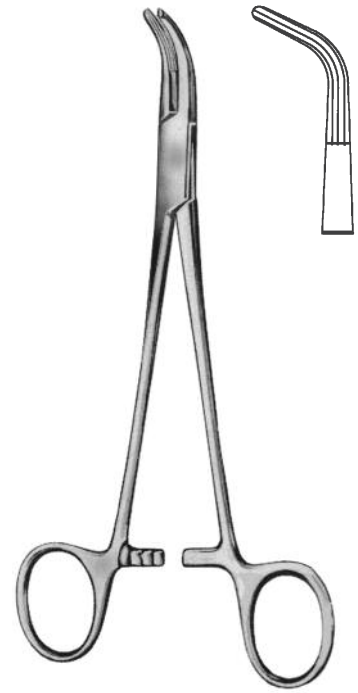

Lower
 18,0 cm 05-365-18



Mixer-O'Shaughnessy
 15,0 cm 05-367-15
 19,0 cm 05-367-19



Desjardins
 21,0 cm 05-369-21

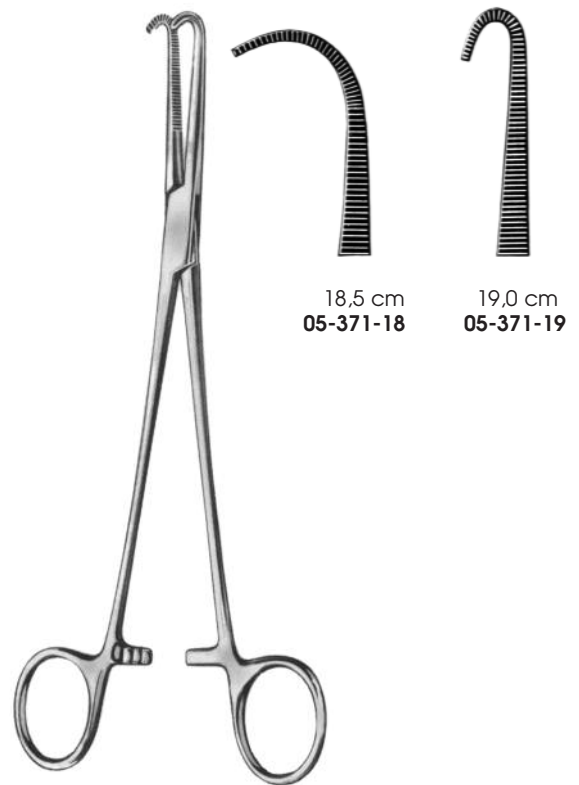

18,5 cm
 05-371-18

19,0 cm
 05-371-19

Negus



Guyon

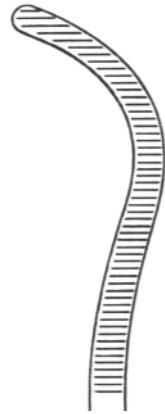

20,0 cm
05-373-20

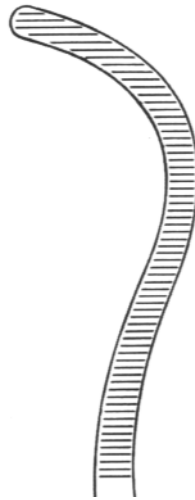

22,0 cm
05-373-22

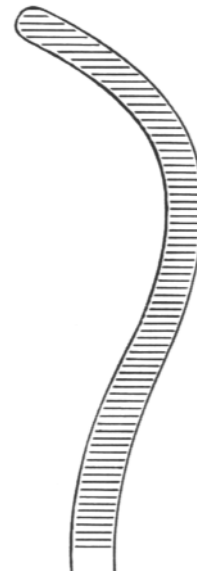

24,0 cm
05-373-24



Guyon
23,0 cm 05-375-23

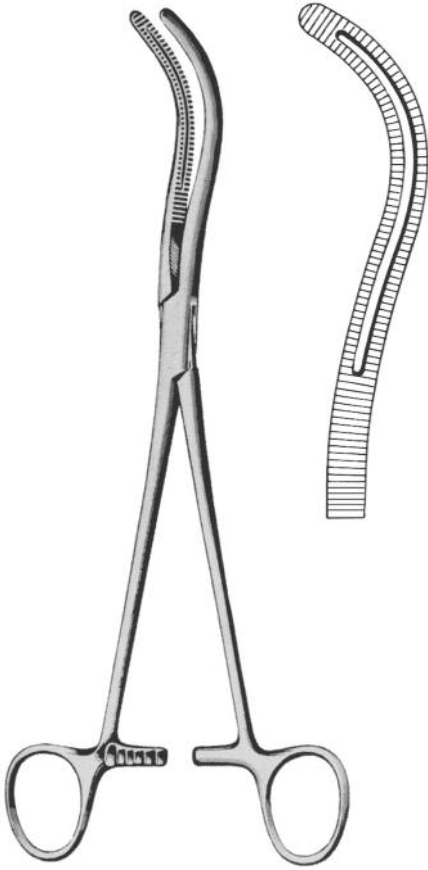

Stille
 23,0 cm 05-377-23

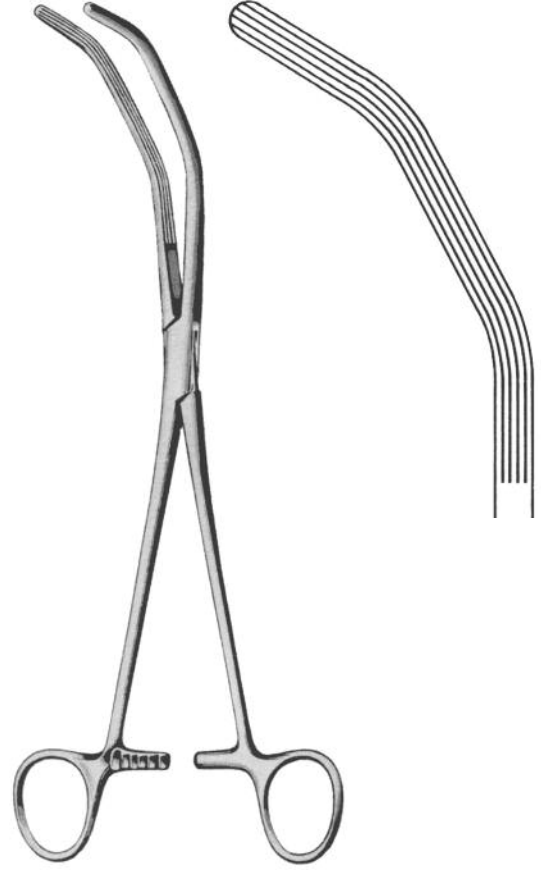

Herrick
 23,0 cm 05-379-23

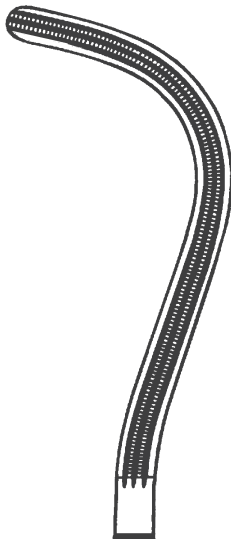

23,0 cm
 05-383-23



24,0 cm
 05-383-24



Guyon

De Bakey - Atrauma



Price - Thomas
22,0 cm 05-390-22

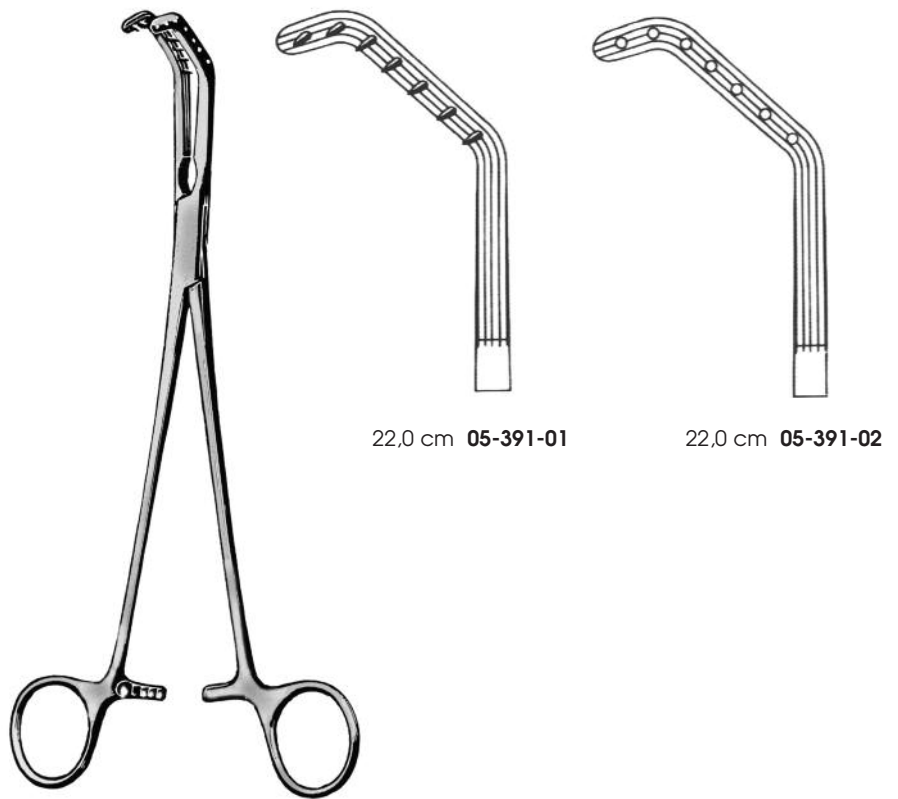

22,0 cm 05-391-01

22,0 cm 05-391-02

Price - Thomas



05-490-10
50 mm
10 mm



05-490-14
50 mm
14 mm



05-490-20
60 mm
20 mm



Gesamtlänge/Total length
Maullänge/Lenght of jaw



05-491-10
50 mm
10 mm



05-491-14
50 mm
14 mm



05-491-20
60 mm
20 mm



Gesamtlänge/Total length
Maullänge/Lenght of jaw



05-492-50
50 mm
20 mm



05-493-48
50 mm
20 mm



Gesamtlänge **Maullänge**
Total length Lenght of jaw



05-494-08
05-494-09
05-494-10
05-494-12



05-495-08
05-495-09
05-495-10
05-495-11



Glover
Gesamtlänge **Maullänge**
Total length Lenght of jaw



05-496-06
05-496-07
05-496-10
05-496-12



05-497-06
05-497-07
05-497-09
05-497-11

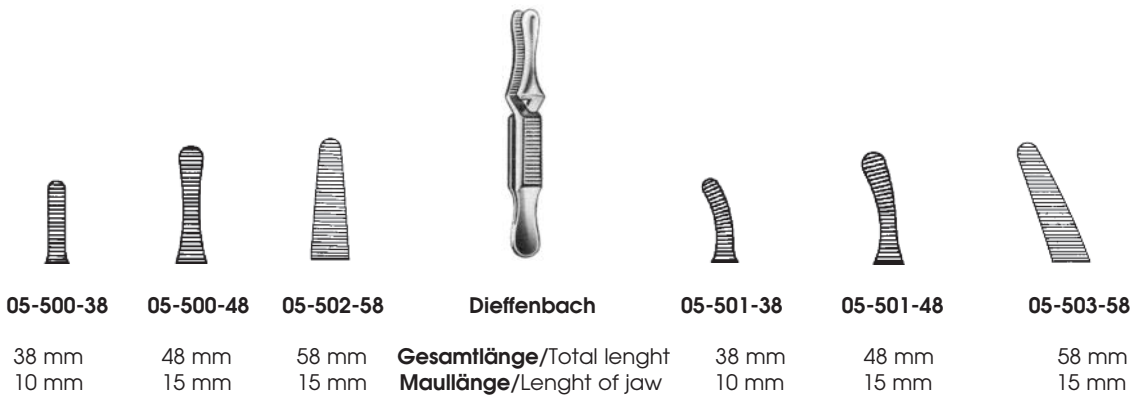
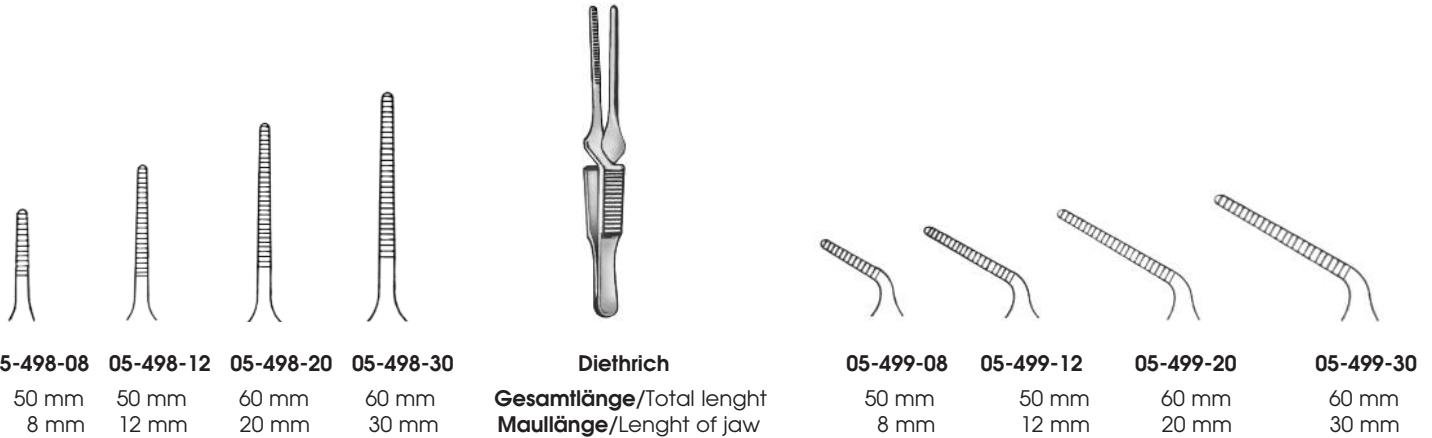

Johns-Hopkins
38 mm **05-505-38**
48 mm **05-505-48**
56 mm **05-505-56**
63 mm **05-505-63**
70 mm **05-505-70**
80 mm **05-505-80**
91 mm **05-505-91**

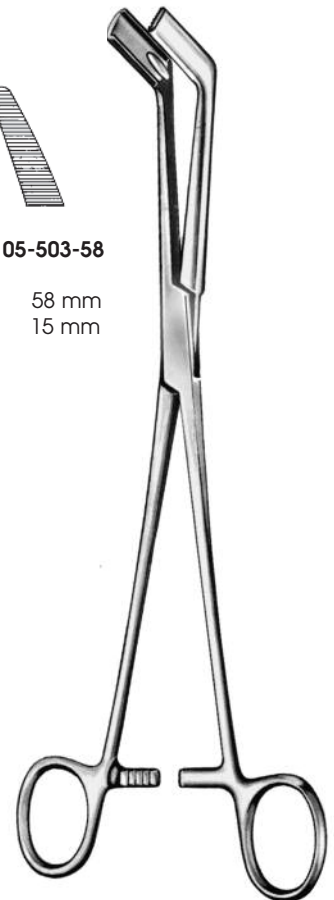

Anlegezange für Bulldogklemmen
Setting Forceps for Bulldog Clamps
24, cm **05-507-24**

Titan/Titanium

V = Vena
 A = Ateria



30,0 mm

35,0 mm

40,0 mm

50,0 mm

V =
 A =

05-512-30
05-516-30

05-512-35
05-516-35

05-512-40
05-516-40

05-512-50
05-516-50



30,0 mm

35,0 mm

40,0 mm

50,0 mm

V =
 A =

05-513-30
05-517-30

05-513-35
05-517-35

05-513-40
05-517-40

05-513-50
05-517-50



30,0 mm

35,0 mm

40,0 mm

50,0 mm

V =
 A =

05-515-30
05-519-30

05-515-35
05-519-35

05-515-40
05-519-40

05-515-50
05-519-50



Satinsky
70 mm **05-525-07**



Carotis
90 mm **05-527-09**



Satinsky
100 mm **05-529-10**



Carotis
50 mm **05-531-05**

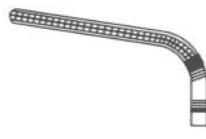

Santulli
70 mm **05-533-07**

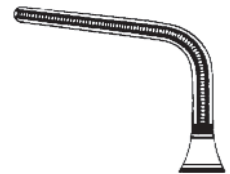

Gregory-Soft

90 mm **05-535-09**

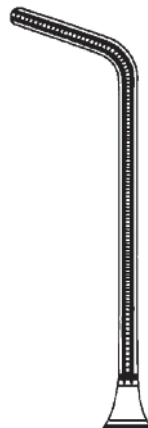

110 mm **05-535-11**

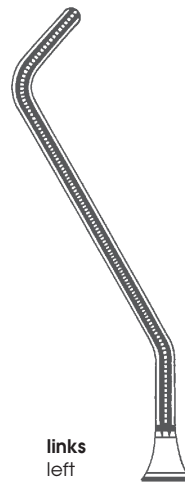

links
left

110 mm **05-537-01**



Gregory-Soft

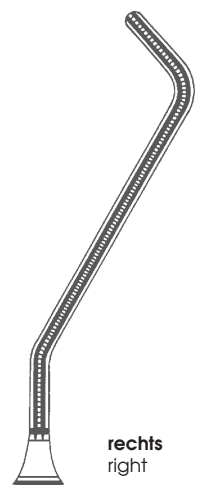

rechts
right

110 mm **05-537-02**

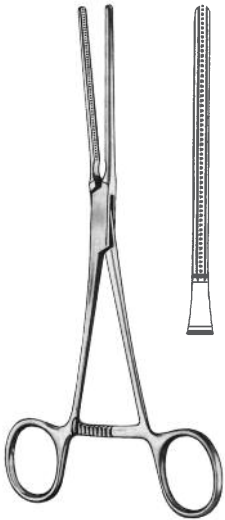

Castaneda
 12,0 cm **05-540-13**



Castaneda

12,0 cm, 30°
05-541-01

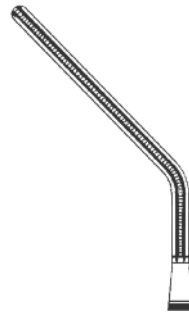

12,0 cm, 45°
05-541-02



11,0 cm, 90°
05-541-03



Castaneda



Fig. 1
 15,0 cm **05-543-01**



Fig. 2
 15,0 cm **05-543-02**



Fig. 3
 15,0 cm **05-543-03**

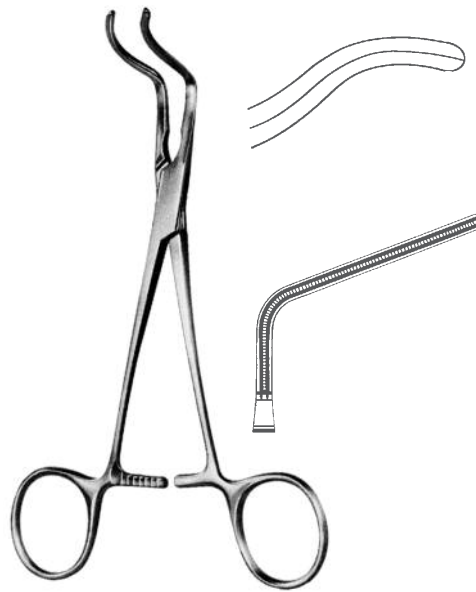

Subramanian-Miniature
15,5 cm 05-545-15

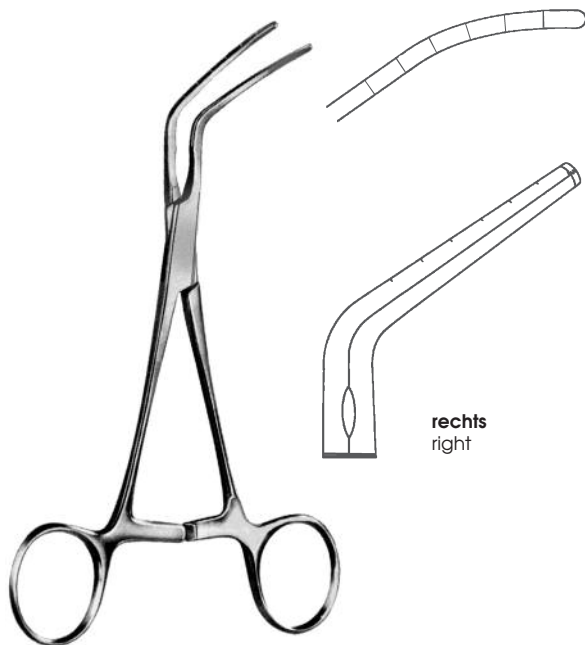

Subramanian
16,0 cm 05-547-16

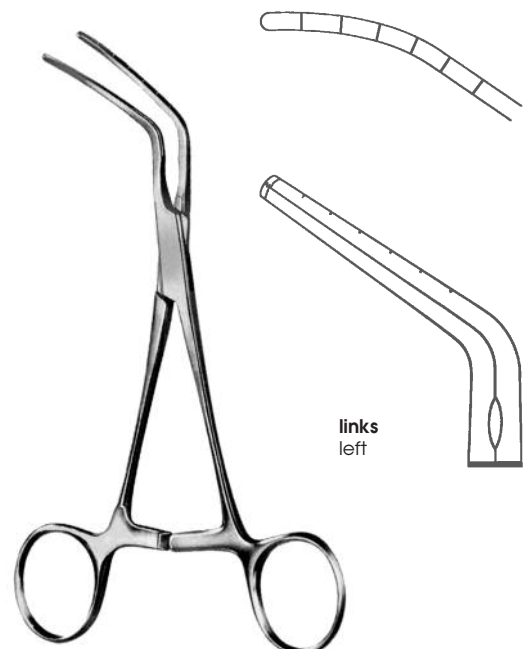

Subramanian
16,0 cm 05-549-16

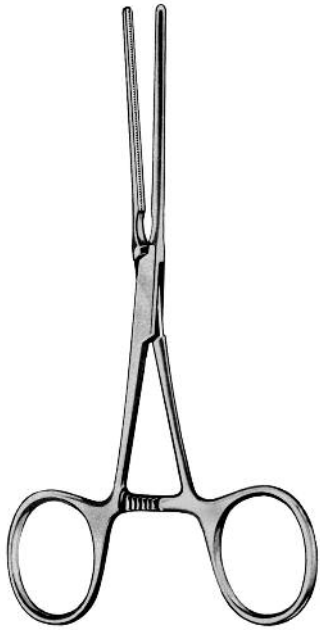

De Bakey



12,0 cm
 05-554-12

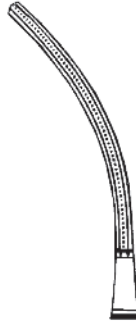

11,0 cm
 05-555-11



10,0 cm
 05-557-10



De Bakey



s-gebogen
 s-curved

12,0 cm
 05-559-12

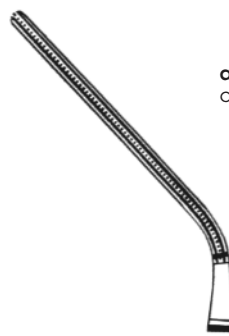

abgewinkelt
 angled

13,0 cm
 05-561-13



De Bakey



17,0 cm
05-562-17



16,0 cm, 30°
05-563-16

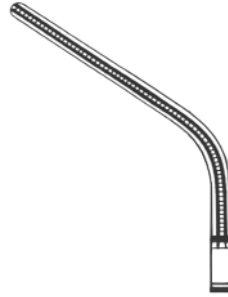

15,0 cm, 60°
05-565-15



15,0 cm, 90°
05-567-15



17,0 cm, 15°
05-569-17



17,0 cm
05-571-17



17,0 cm
05-573-17



De Bakey

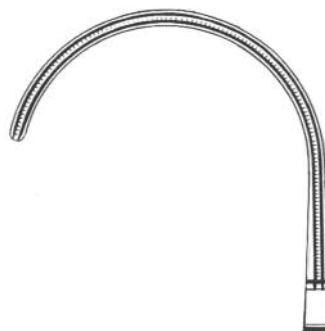

16,0 cm
05-575-16



17,0 cm
05-575-17



Derra

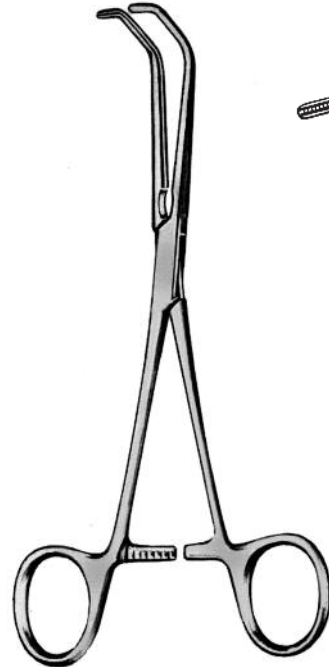
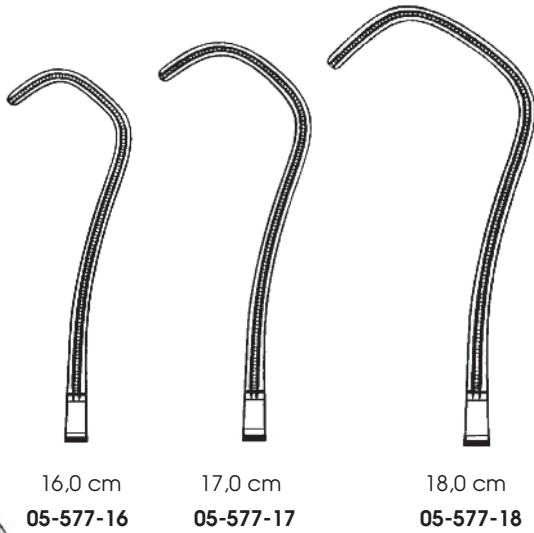

Beck

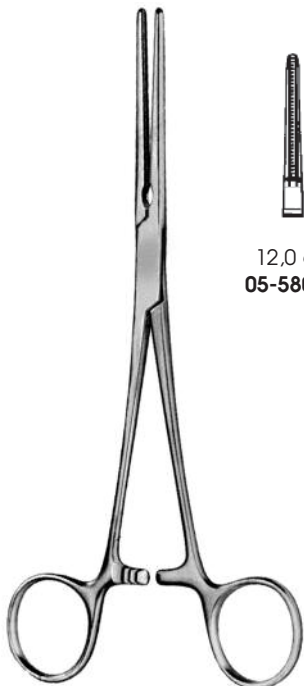
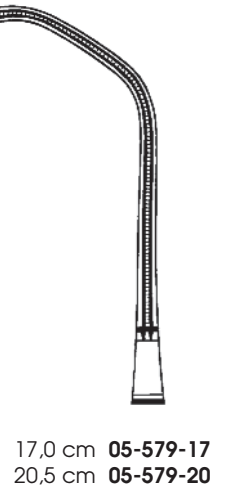

De Bakey-Pean

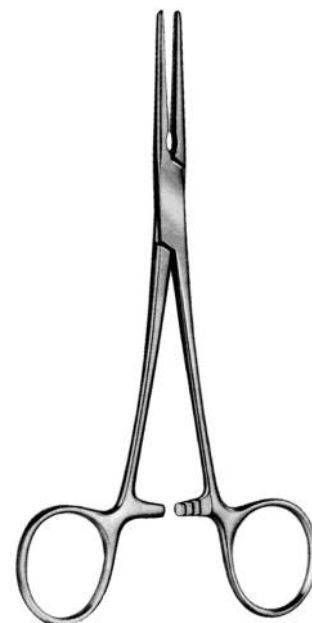
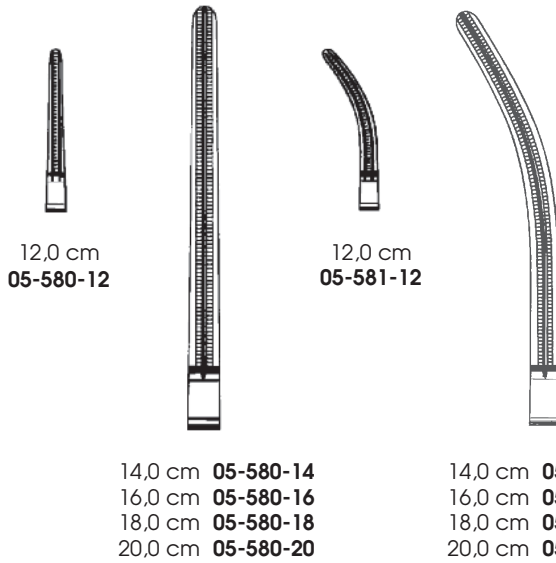

De Bakey





De Bakey



21,5 cm
05-584-21

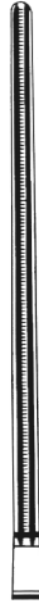

23,0 cm
05-584-23



27,0 cm
05-584-27



31,5 cm
05-584-31



21,5 cm
05-585-21



23,0 cm
05-585-23



27,0 cm
05-585-27



31,5 cm
05-585-31

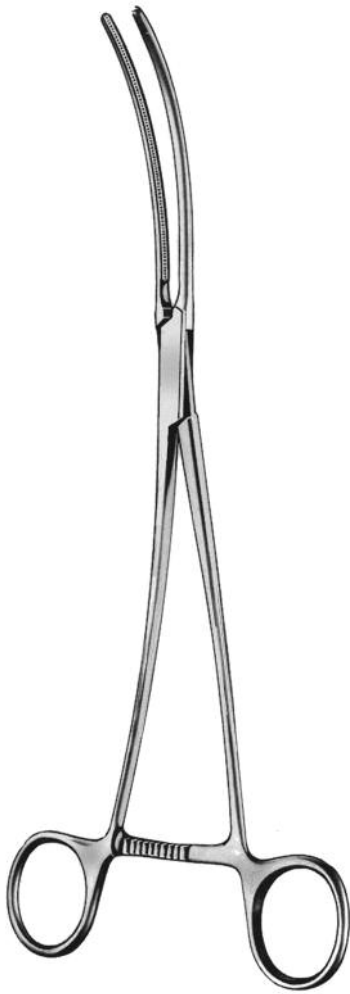

De Bakey

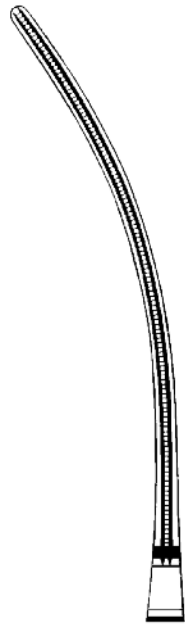

26,0 cm
 05-587-26

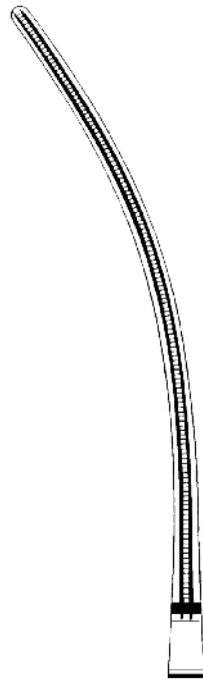

27,0 cm
 05-587-27

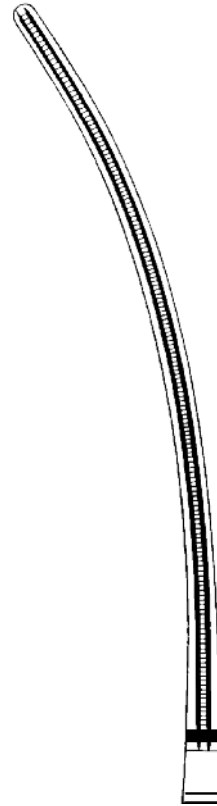

31,0 cm
 05-587-31

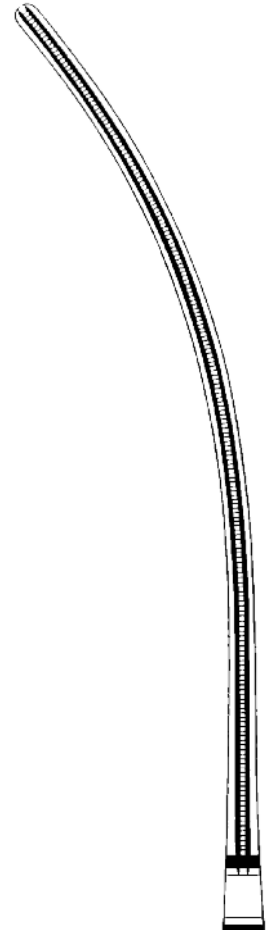

33,0 cm
 05-587-33



De Bakey-Bahson

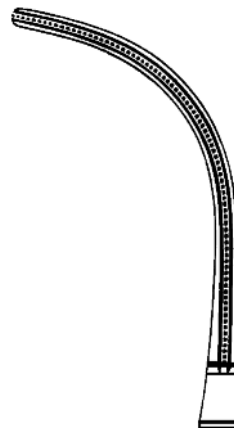

23,0 cm
 05-589-23

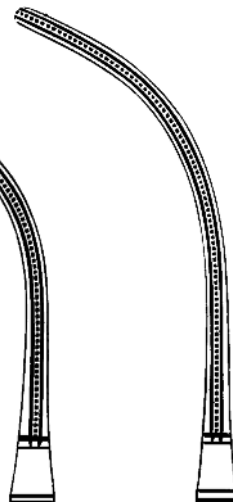

24,0 cm
 05-589-24

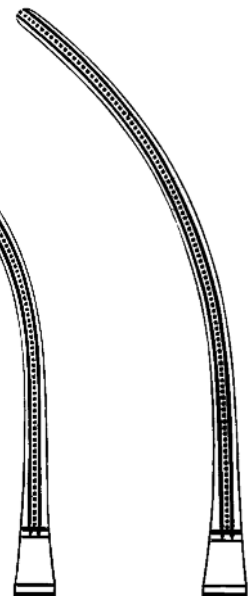

25,0 cm
 05-589-25



De Bakey

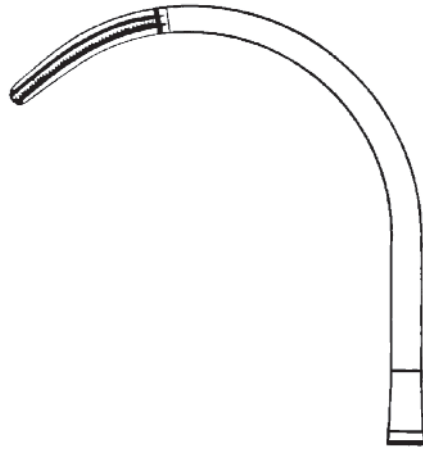

27,0 cm
05-591-25

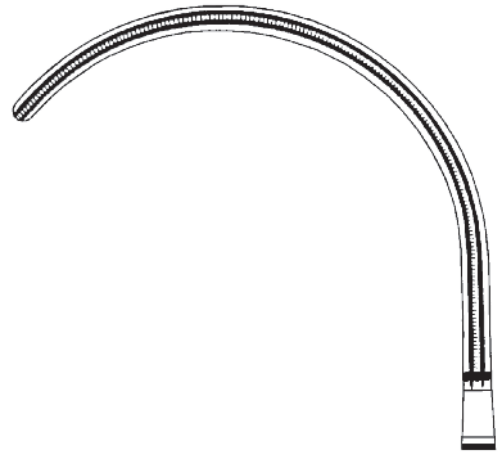

26,0 cm
05-591-26

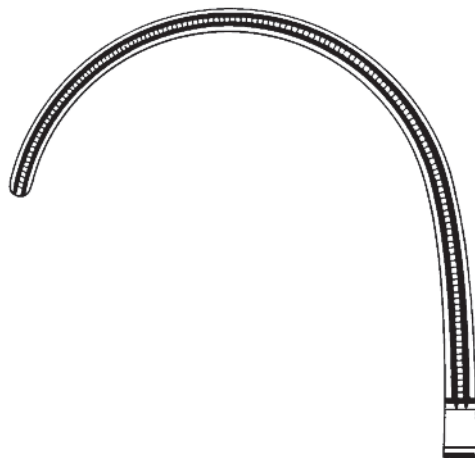

links abgebogen
left curved

25,0 cm 05-593-01

rechts abgebogen
right curved

25,0 cm 05-593-02

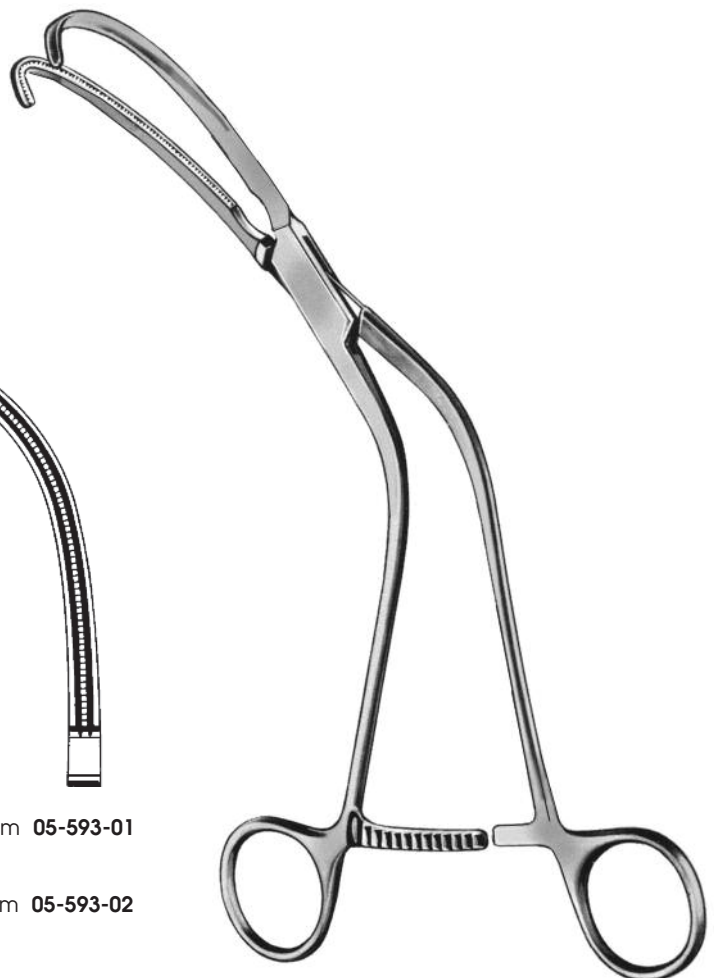

Weber



De Bakey
 28,0 cm 05-595-28

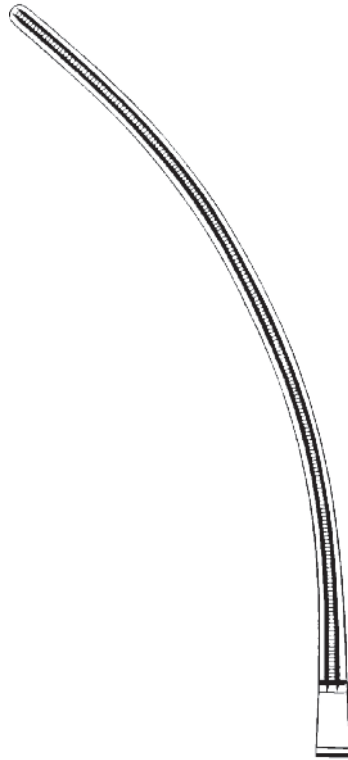

De Bakey
 30,0 cm 05-595-30



Brainbridge



15,0 cm
 05-596-15



18,0 cm
 05-596-18



15,0 cm
 05-597-15



18,0 cm
 05-597-18



De Bakey
20,0 cm 05-599-20



Lees
24,5 cm 05-599-24



Glover

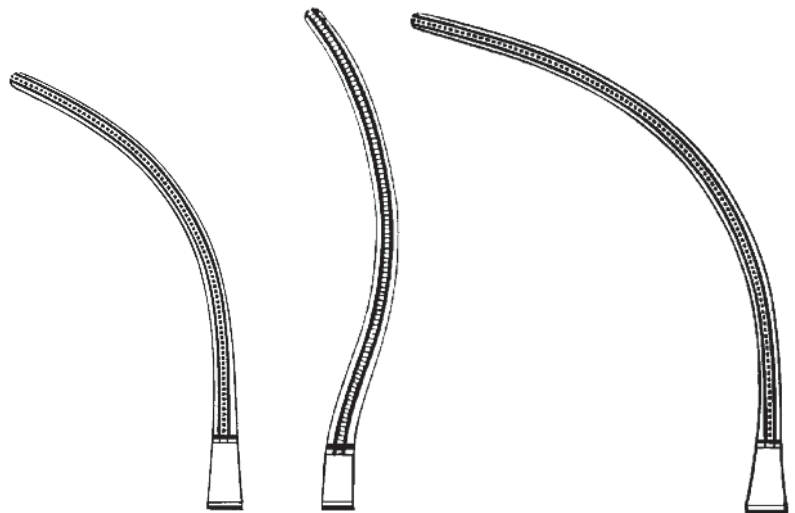

22,0 cm
05-601-22

22,5 cm
05-601-23

24,5 cm
05-601-24



De Bakey



19,0 cm
05-605-19

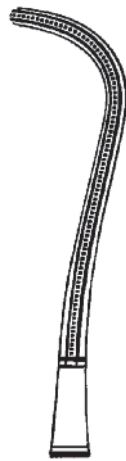

23,0 cm
05-605-23



De Bakey
 16,0 cm **05-607-16**

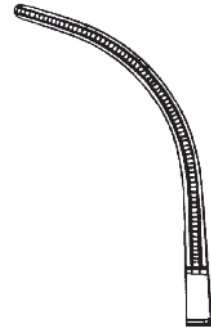

De Bakey

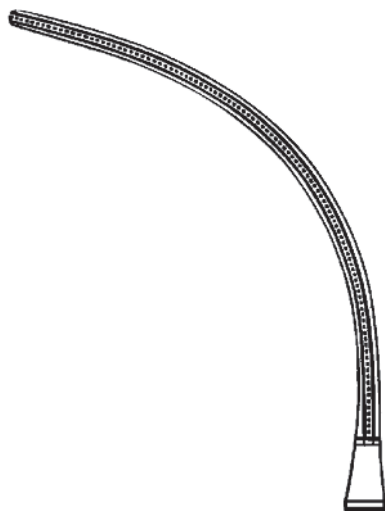

19,0 cm
05-609-19

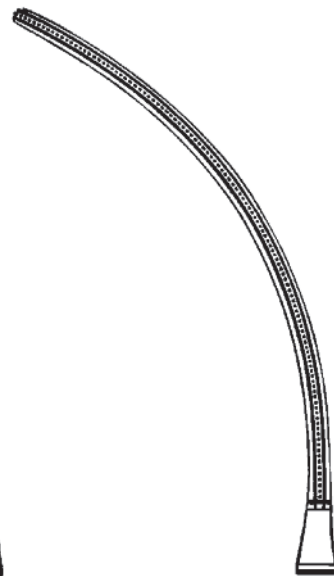

20,0 cm
05-609-20

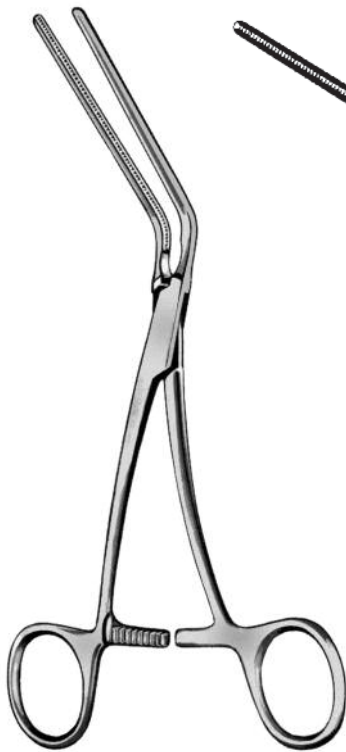

Leland

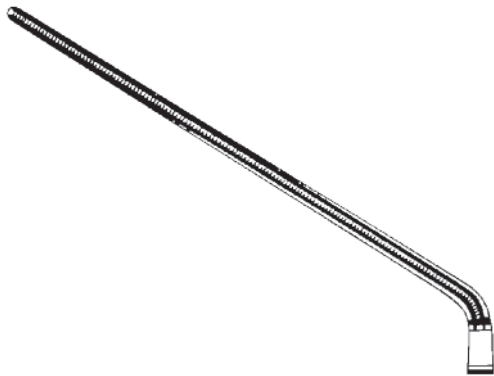

18,0 cm
05-611-18



19,0 cm
05-611-19



20,0 cm
05-611-20



21,0 cm
05-612-21



22,0 cm
05-612-22



24,0 cm
05-612-24



De Bakey



De Bakey



21,0 cm
05-613-21



22,0 cm
05-613-22



24,0 cm
05-613-24



21,0 cm
05-615-21



22,0 cm
05-615-22



De Bakey



De Bakey

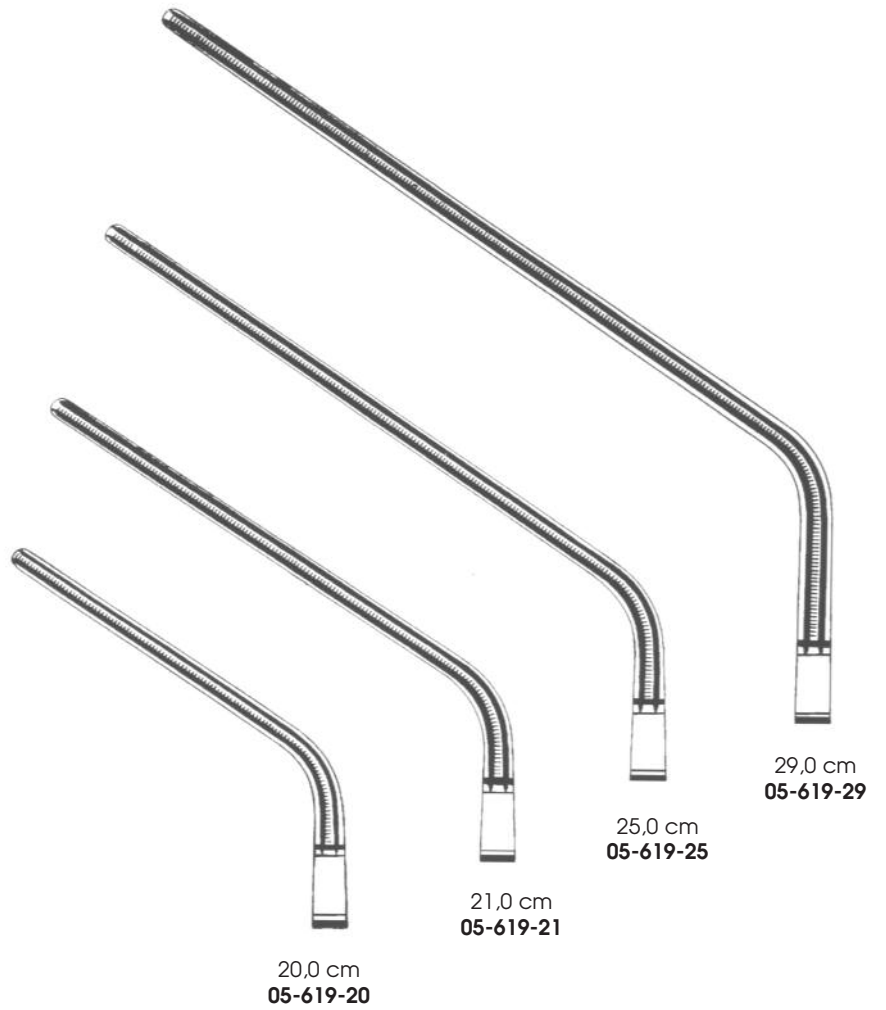
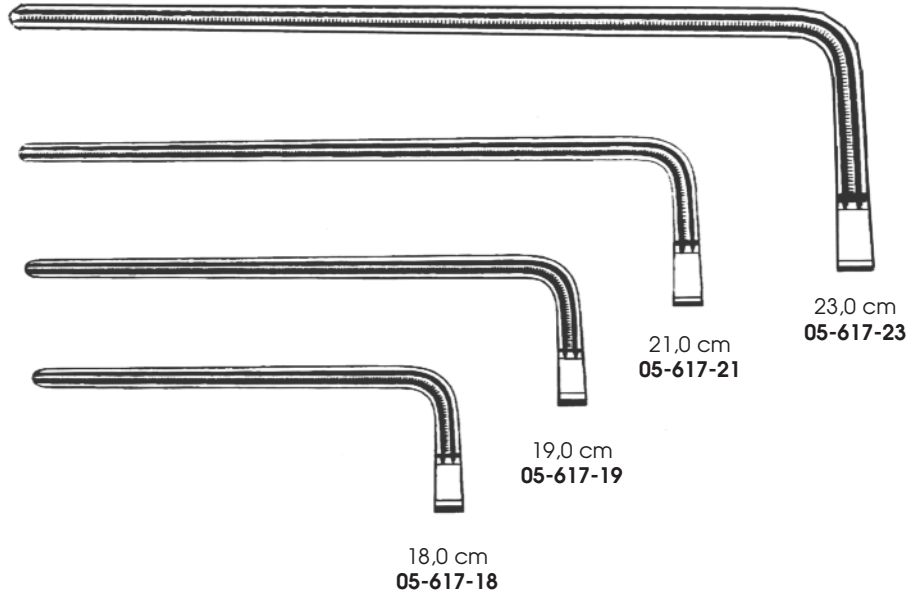



Lees

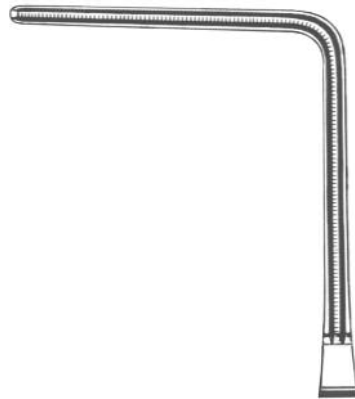

23,0 cm
05-621-23



25,0 cm
05-621-25



Lees

25,0 cm 05-623-25



Morris-De Bakey

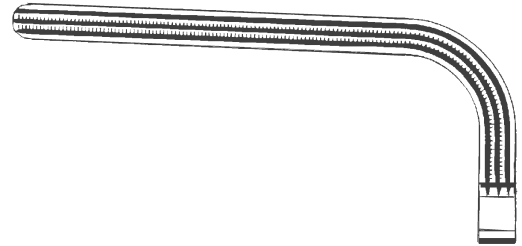

18,0 cm
05-625-01

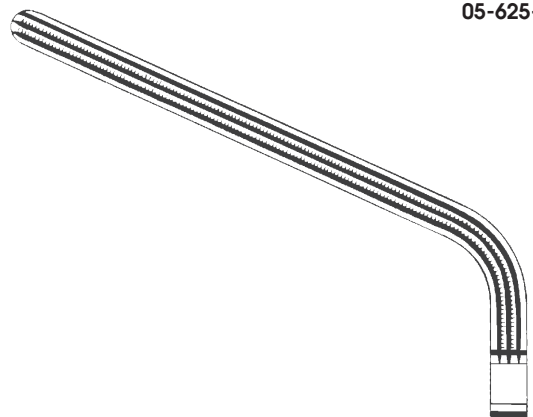

20,0 cm
05-625-03

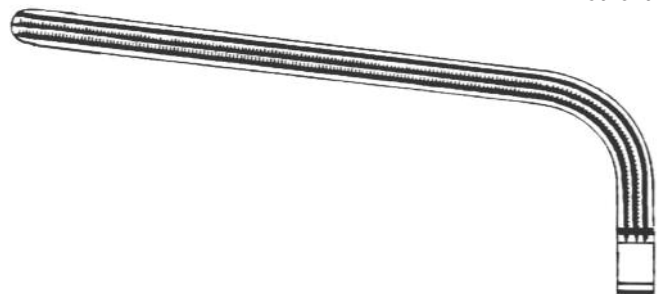

23,0 cm
05-625-04

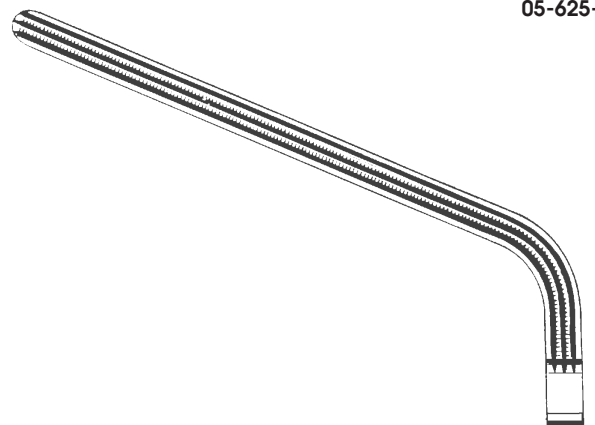

24,0 cm
05-625-05

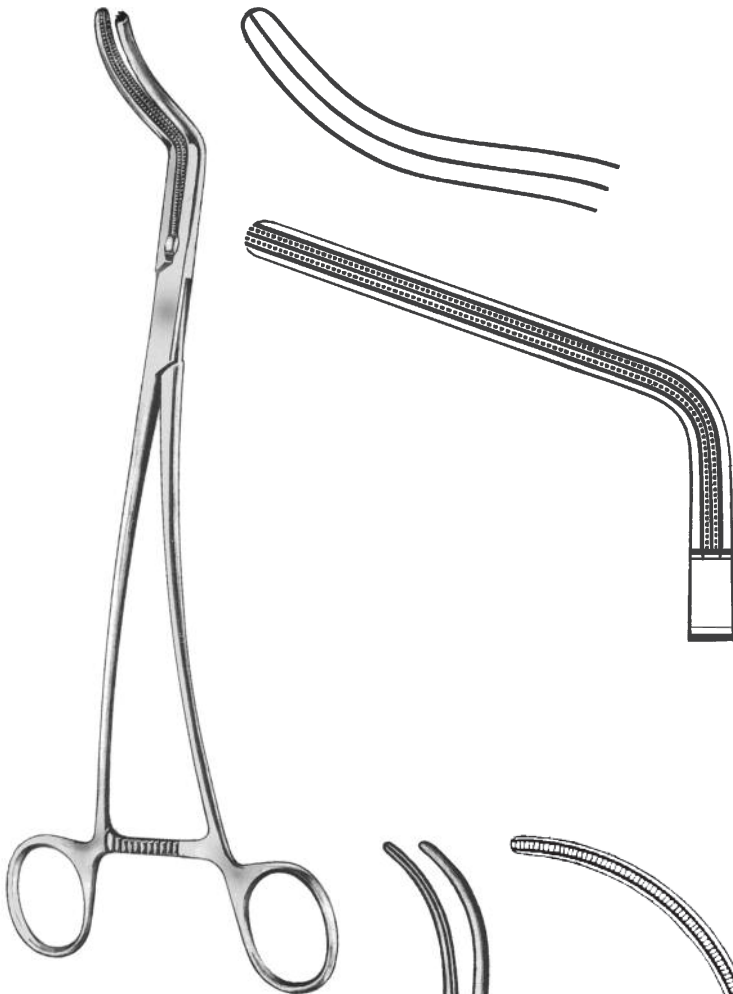

De Bakay
27,0 cm 05-627-27

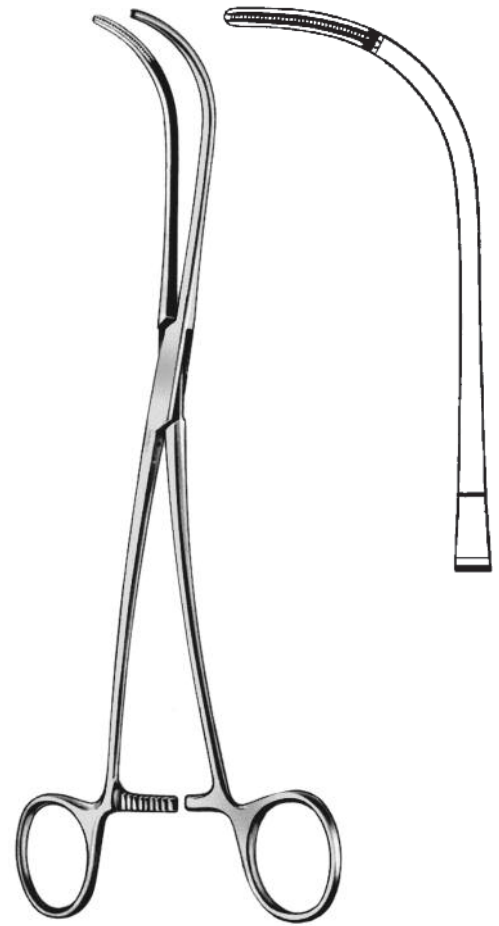

De Bakay
24,0 cm 05-629-24

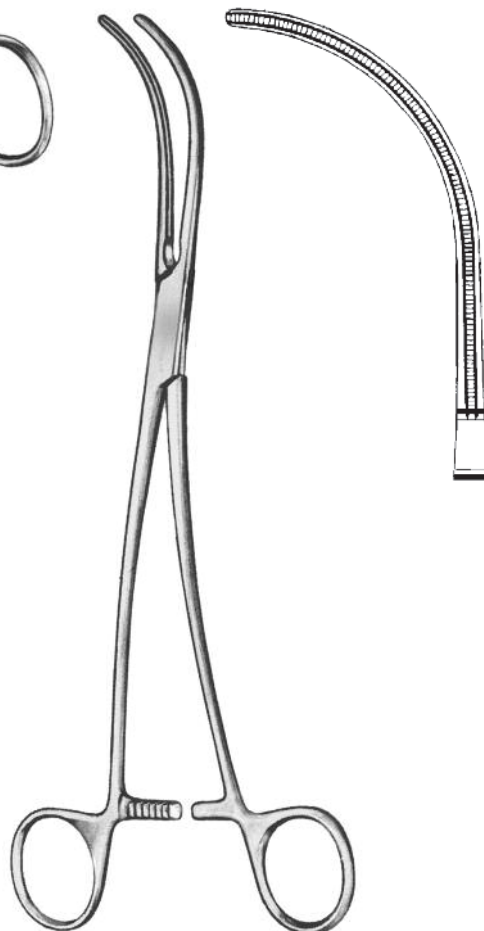

De Bakay
24,0 cm 05-631-24

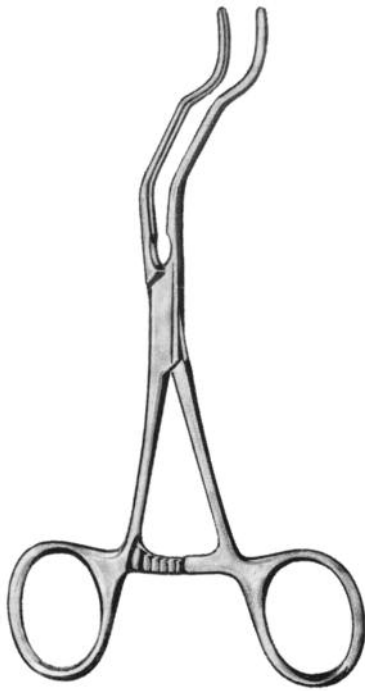

Gregory

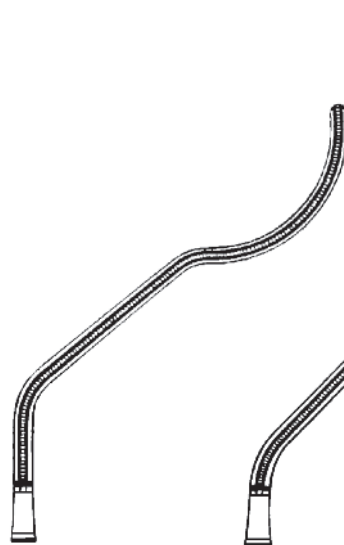

14,0 cm
05-633-14



16,0 cm
05-633-16

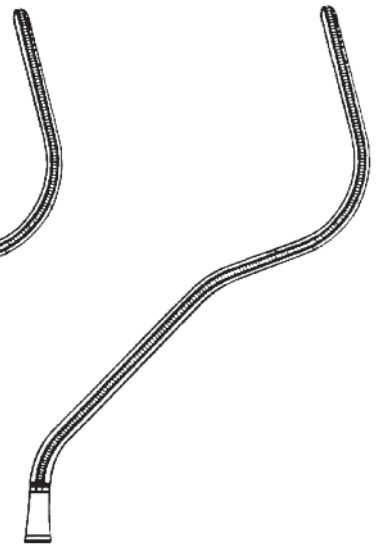

18,0 cm
05-633-18

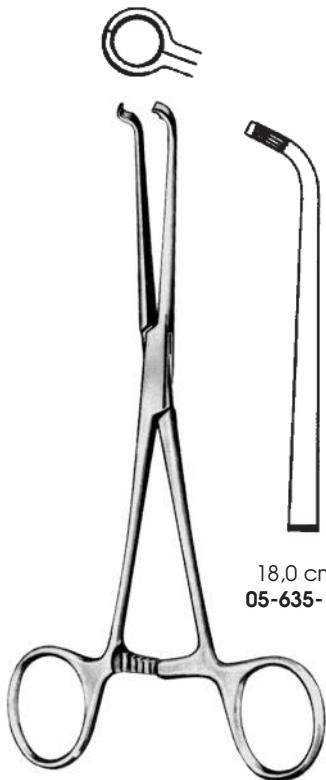

Javid



18,0 cm
05-635-18

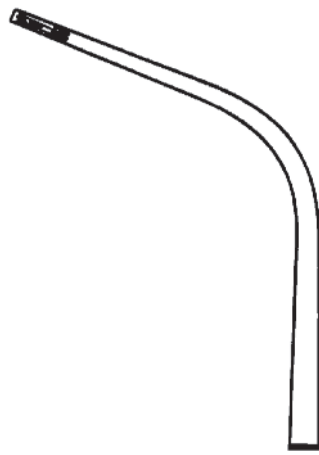

19,0 cm
05-635-19

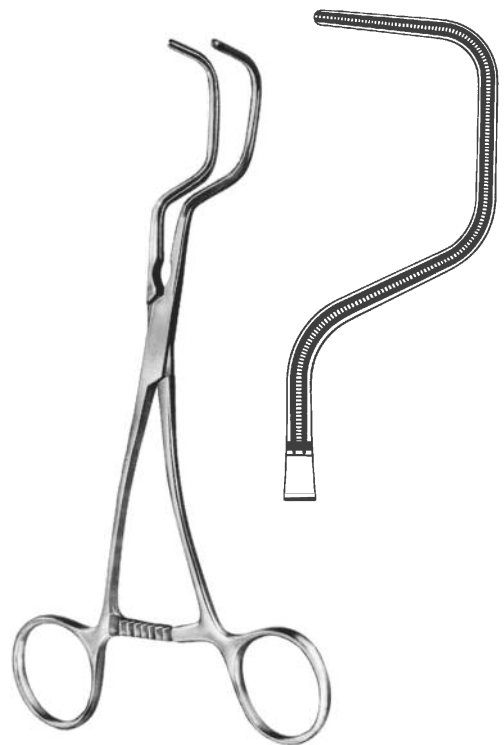

Dale

18,0 cm 05-639-18



Dale



17,0 cm
 05-641-17



18,0 cm
 05-641-18

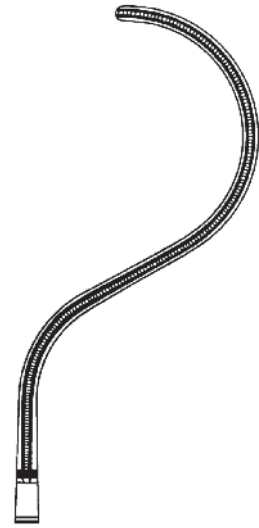

19,0 cm
 05-641-19

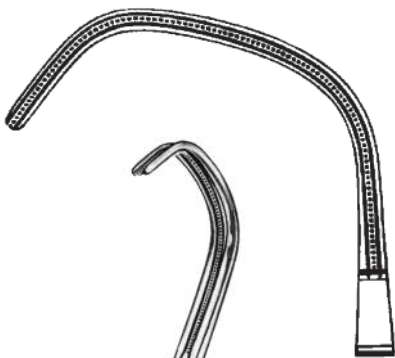

21,0 cm
 05-643-21

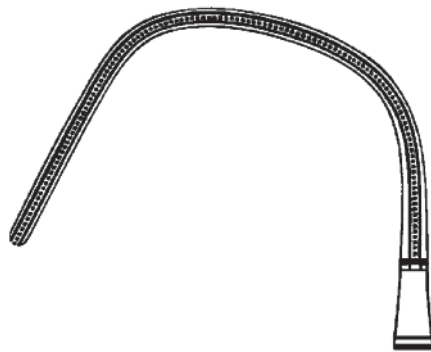

22,0 cm
 05-643-22

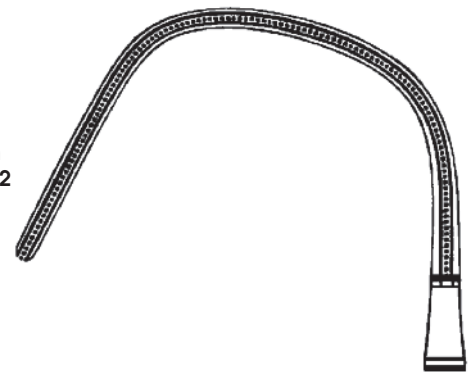

25,0 cm
 05-643-25



Lambert-Kay



17,0 cm 05-645-17

De Bakey



20,0 cm 05-645-20

Cooley-De Bakey



Satinsky

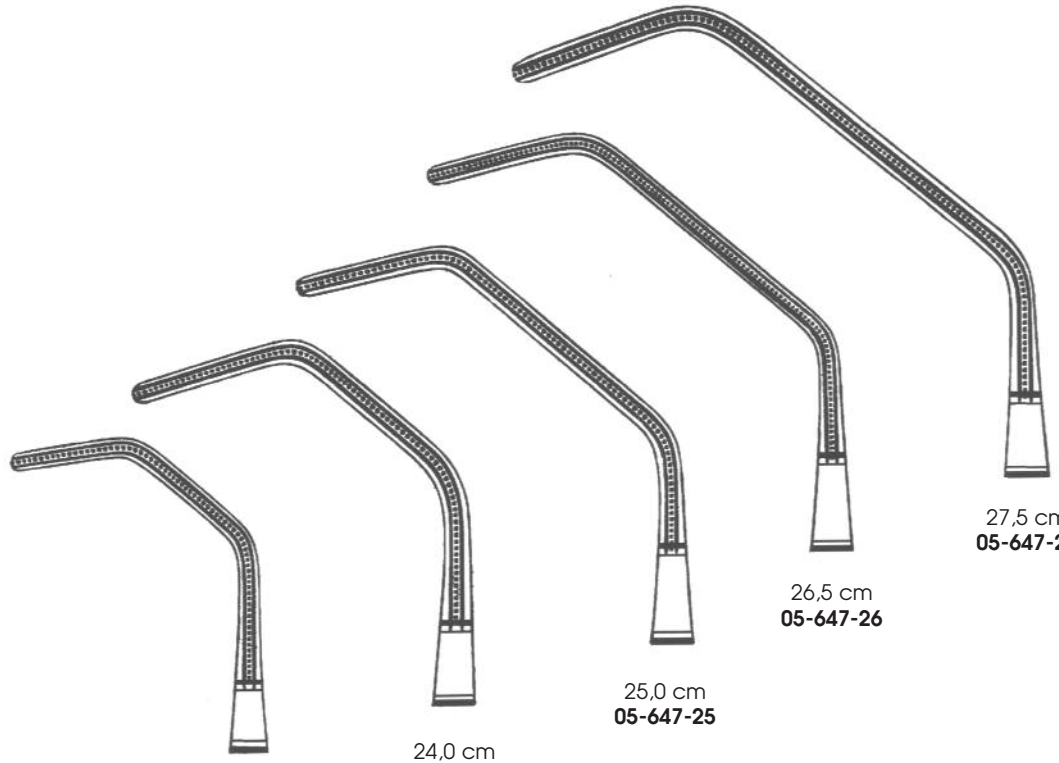

27,5 cm
05-647-27

26,5 cm
05-647-26

25,0 cm
05-647-25

24,0 cm
05-647-24

20,5 cm
05-647-20

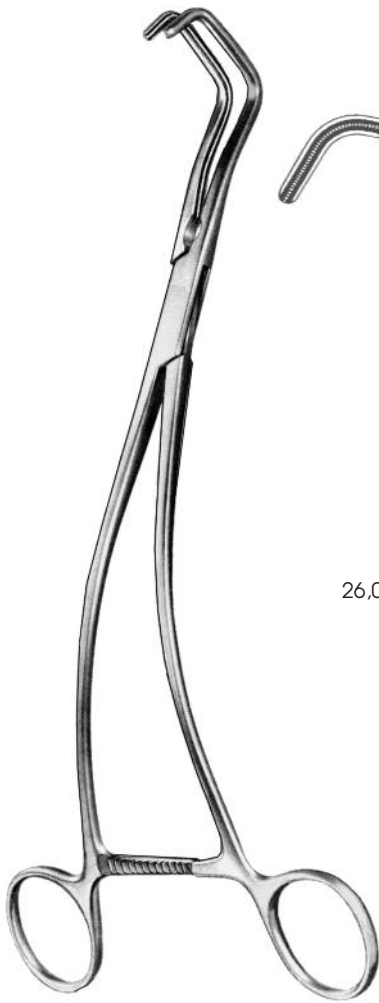

De Bakey

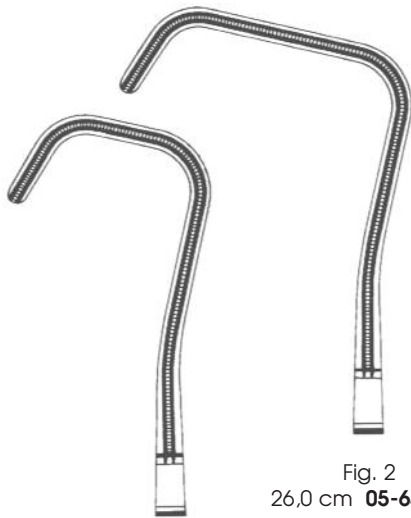

Fig. 1
26,0 cm **05-648-01**

Fig. 2
26,0 cm **05-648-02**



Ochsner
23,5 cm **05-649-23**



Diethrich
21,5 cm **05-651-21**

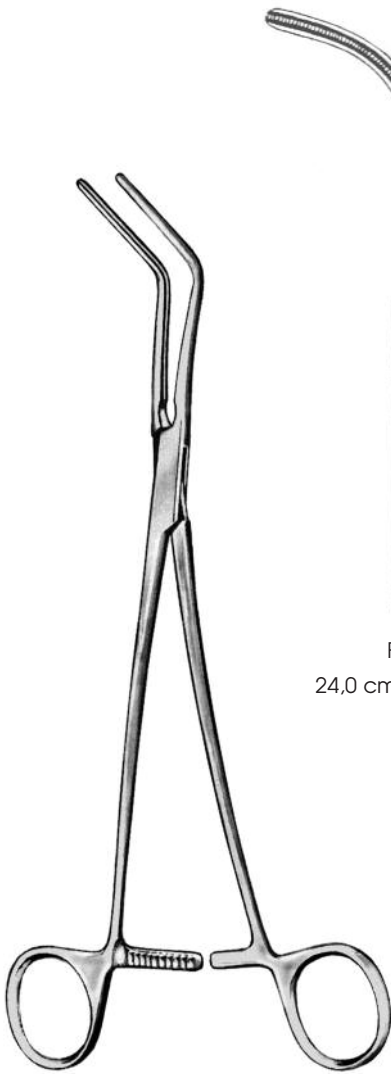

Harken



Fig. 1
24,0 cm 05-653-01



Fig. 2
24,0 cm 05-653-02



Fig. 3
24,0 cm 05-653-03



Fig. 4
24,0 cm 05-653-04



Cooley

14,0 cm



05-654-01



05-654-02



05-654-03

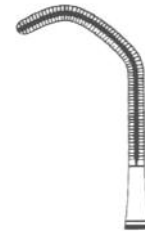

05-654-04



05-654-05

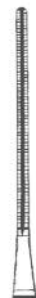

Fig. 1

05-656-01



Fig. 2

05-656-02



Fig. 3

05-656-03



Fig. 4

05-656-04



Fig. 5

05-656-05

gerade /straight
 abgewinkelt/angled
 gebogen/curved

05-657-01

05-657-02

05-657-03

05-657-04

05-657-05

05-659-01

05-659-02

05-659-03

05-659-04

05-659-05

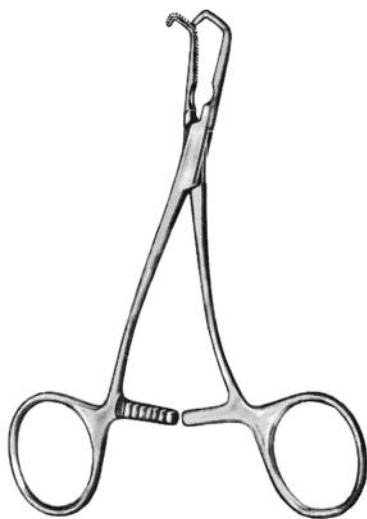

Cooley

14,0 cm



gerade
 straight



abgewinkelt
 angled



gebogen
 curved



Fig. 6

05-656-06

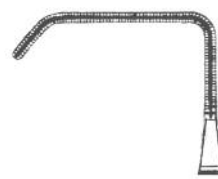

Fig. 7

05-656-07



Fig. 8

05-656-08



Fig. 9

05-656-09

gerade /straight
 abgewinkelt/angled
 gebogen/curved

05-657-06

05-657-07

05-657-08

05-657-09

05-659-06

05-659-07

05-659-08

05-659-09



Cooley

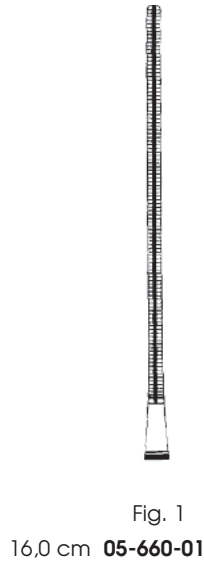

Fig. 1
16,0 cm 05-660-01



Fig. 2
05-660-02

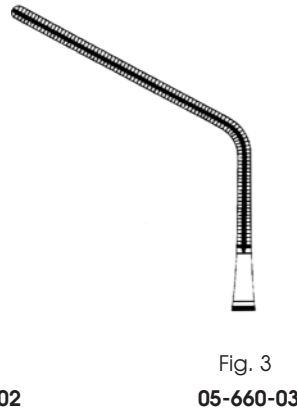

Fig. 3
05-660-03

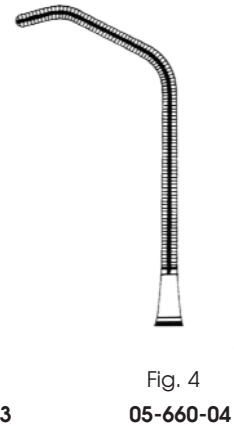

Fig. 4
05-660-04

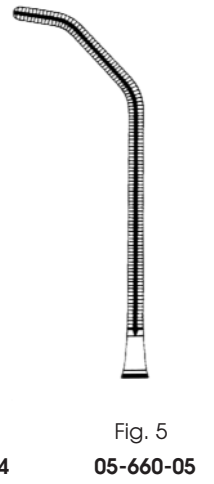

Fig. 5
05-660-05



Cooley

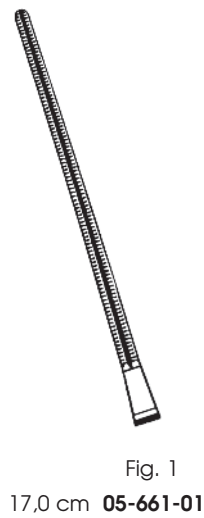

Fig. 1
17,0 cm 05-661-01

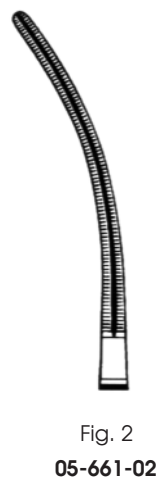

Fig. 2
05-661-02

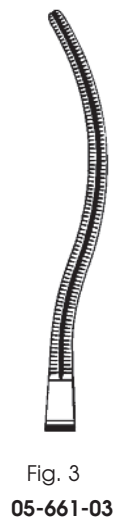

Fig. 3
05-661-03

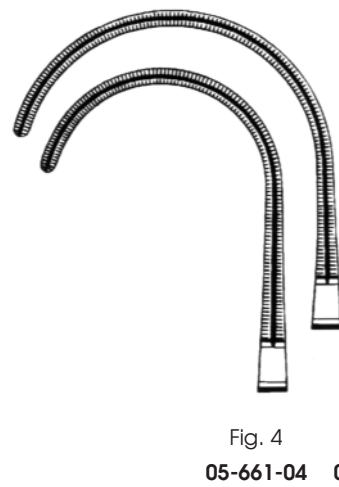

Fig. 4
05-661-04



Fig. 5
05-661-05



Cooley-Derra



17,0 cm **05-663-16**



17,0 cm **05-663-17**



17,0 cm **05-663-18**

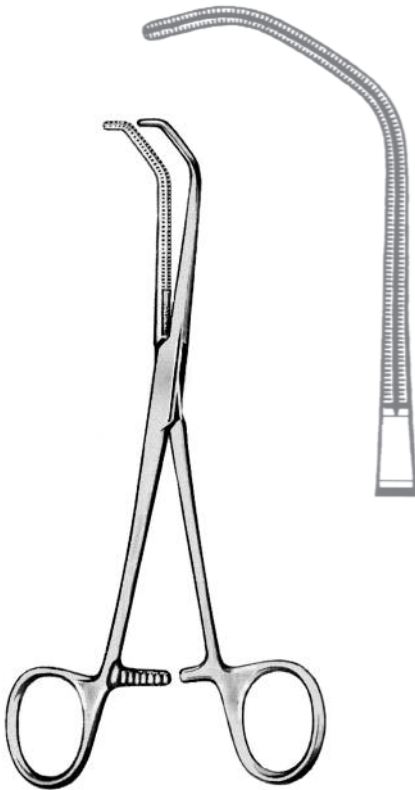

Cooley
 17,0 cm **05-665-17**

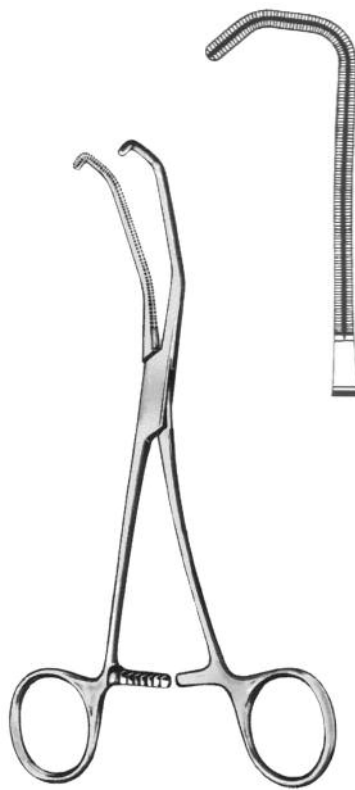

Cooley
 17,0 cm **05-667-17**

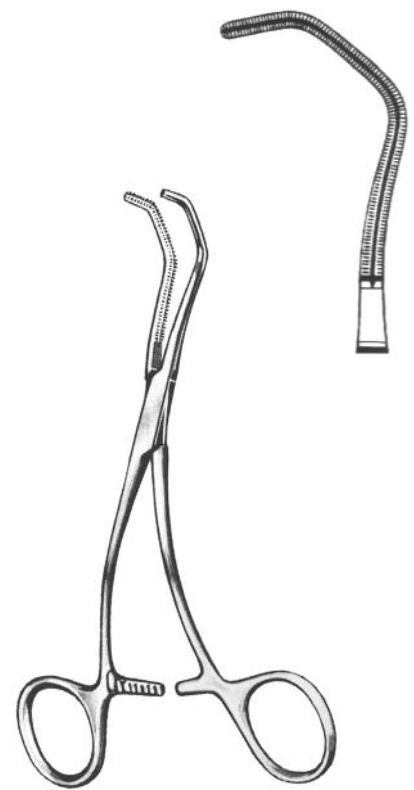

Cooley
 16,0 cm **05-669-16**



Cooley



15,0 cm
05-671-15



16,0 cm
05-671-16

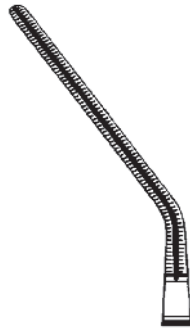

17,0 cm
05-671-17

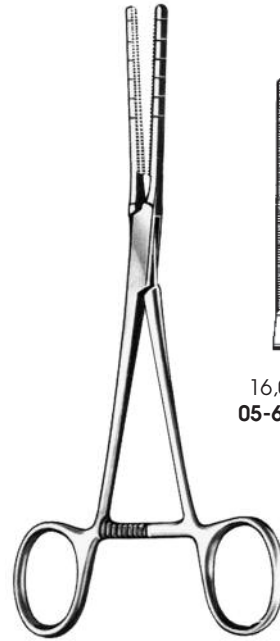

Cooley



16,0 cm
05-672-16



17,0 cm
05-672-17

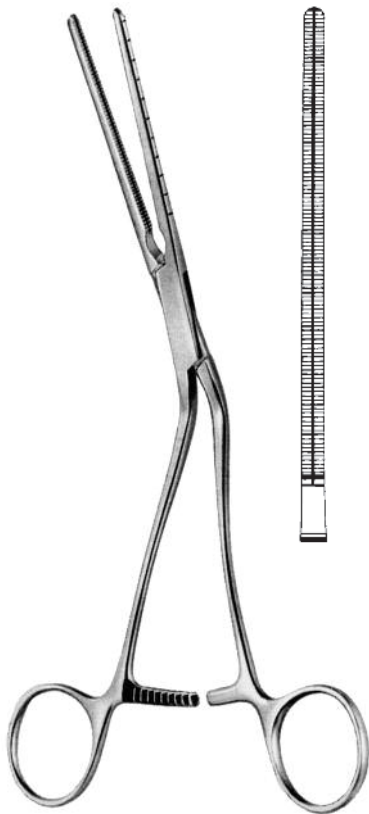

Cooley
21,0 cm 05-673-21

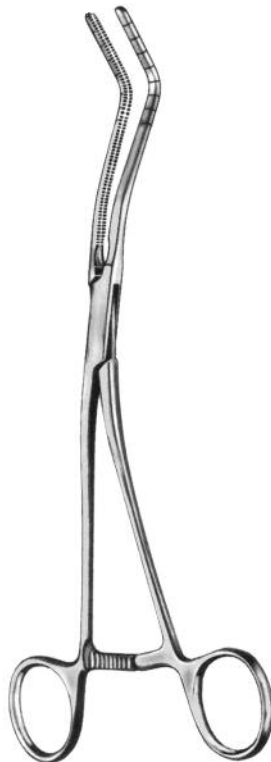

Cooley



20,0 cm 05-675-20

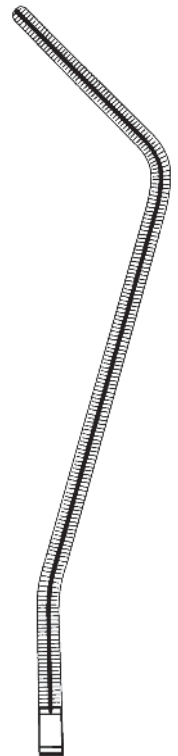

26,0 cm 05-675-26

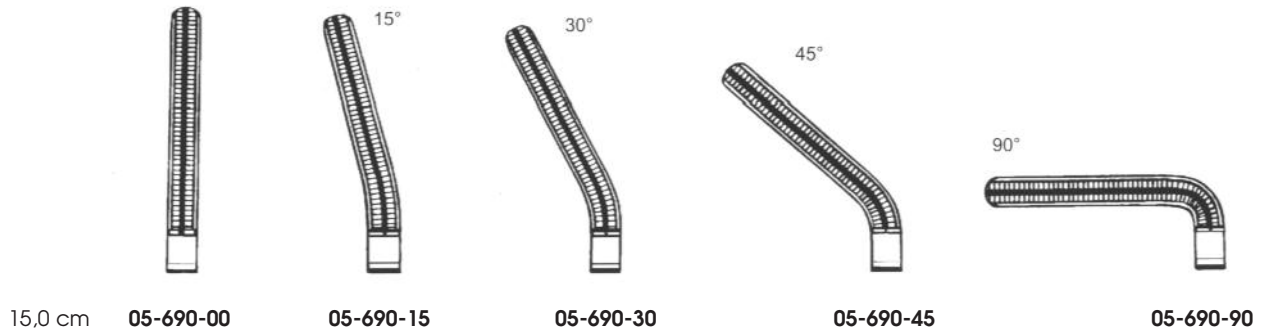

Dardik

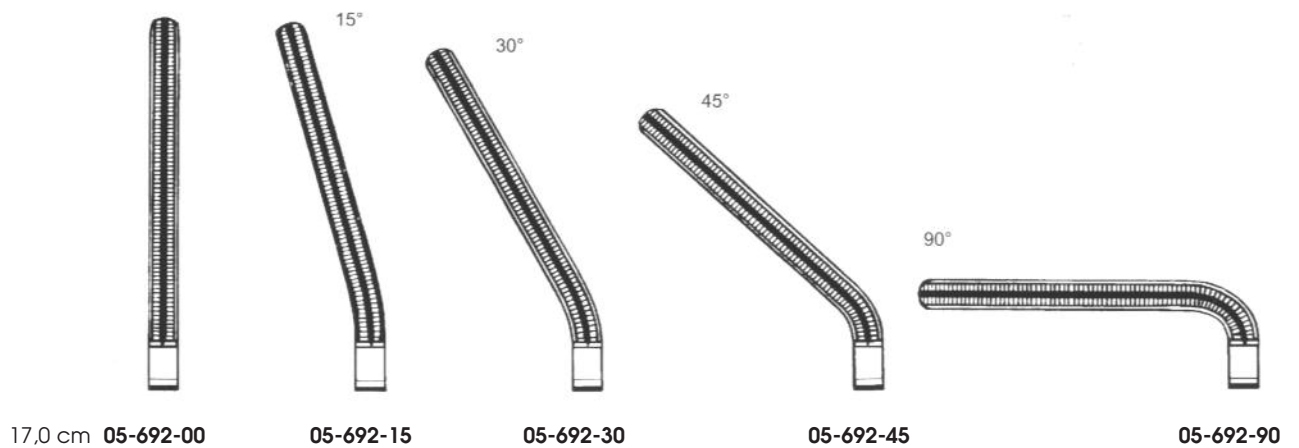

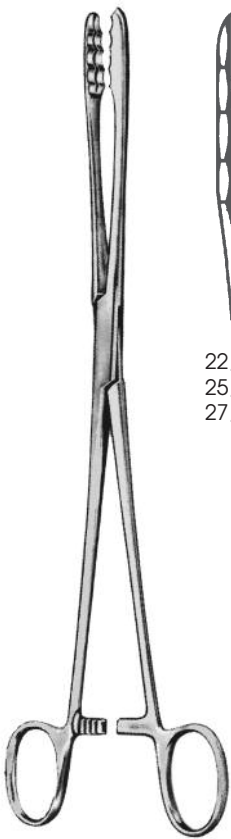

Ulrich

22,0 cm **05-700-22**
25,0 cm **05-700-25**
27,0 cm **05-700-27**

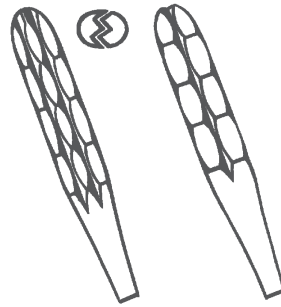

22,0 cm **05-701-22**
25,0 cm **05-701-25**
27,0 cm **05-701-27**

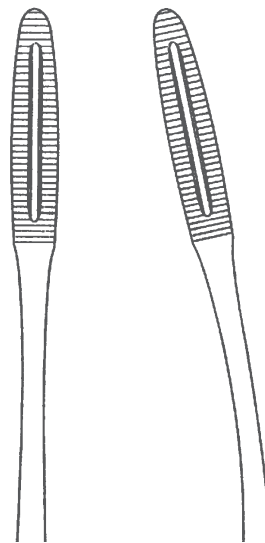

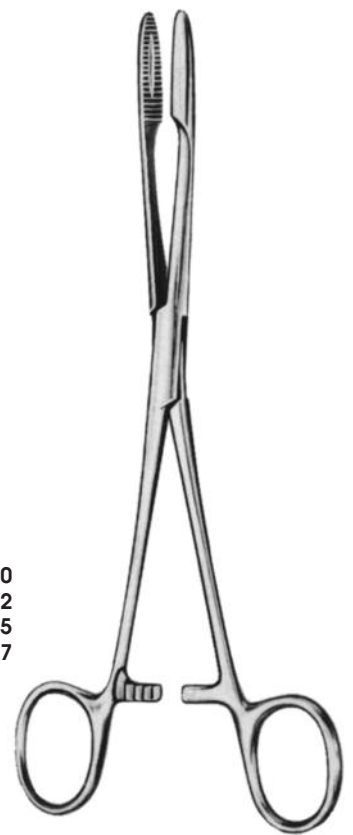

20,0 cm 05-702-20	20,0 cm 05-703-20
22,0 cm 05-702-22	22,0 cm 05-703-22
25,0 cm 05-702-25	25,0 cm 05-703-25
27,0 cm 05-702-27	27,0 cm 05-703-27

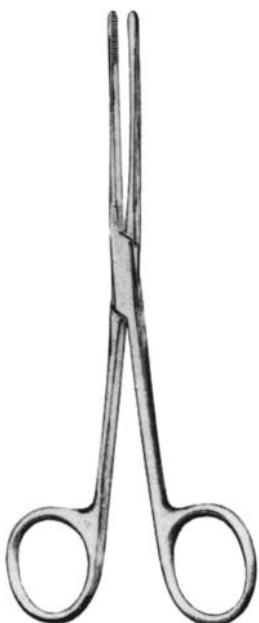

Gross-Maier



Lister, Sinus

		
13,0 cm	16,0 cm	18,0 cm
05-714-13	05-714-16	05-714-18



Bozemann
26,0 cm **05-716-26**

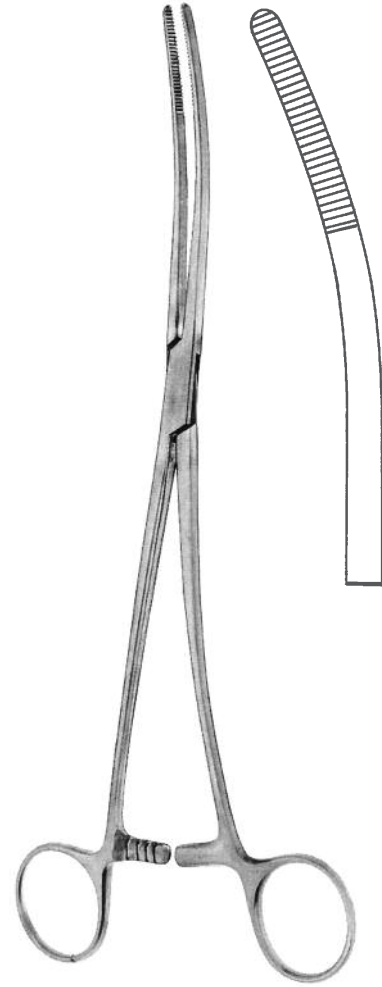

Bozemann
26,0 cm **05-717-26**

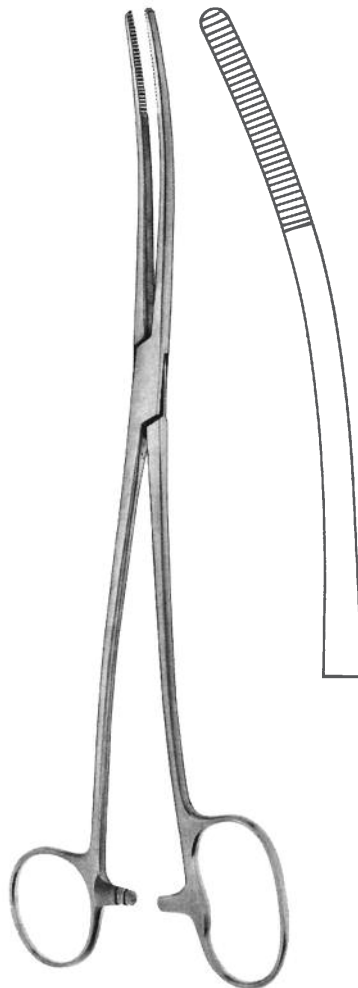

Bozemann
26,0 cm **05-719-26**

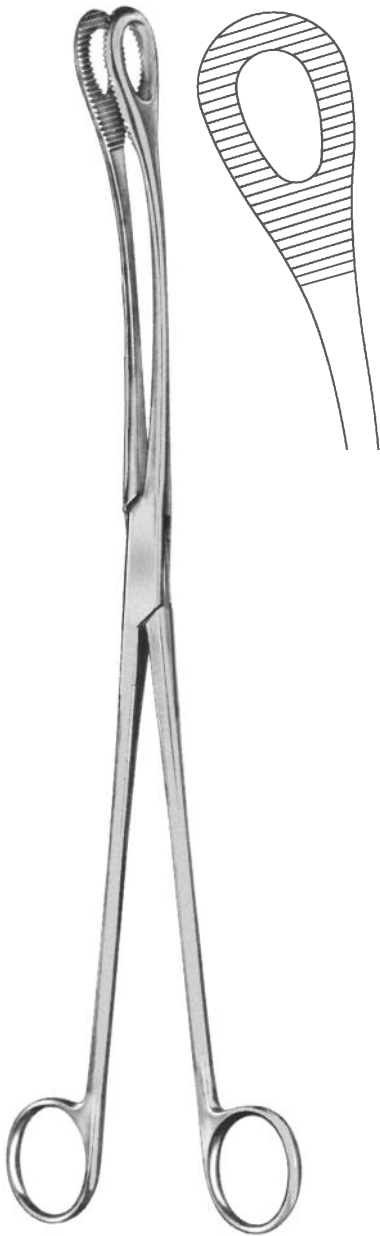

Kelly
32,0 cm 05-725-32



Noto
27,0 cm 05-726-27

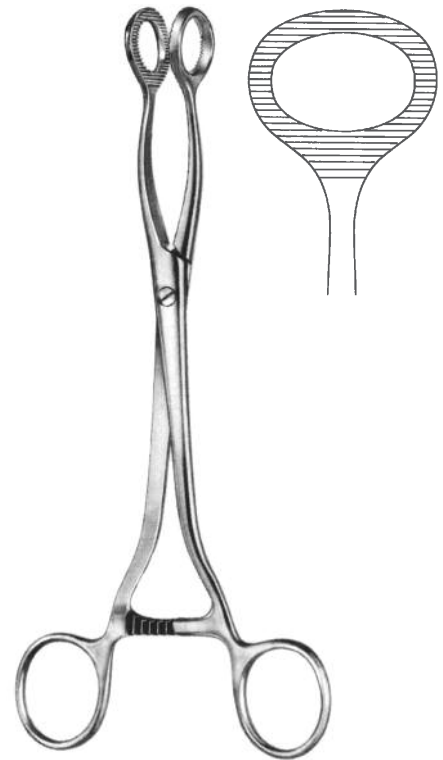

Doyen
20,5 cm 05-730-21

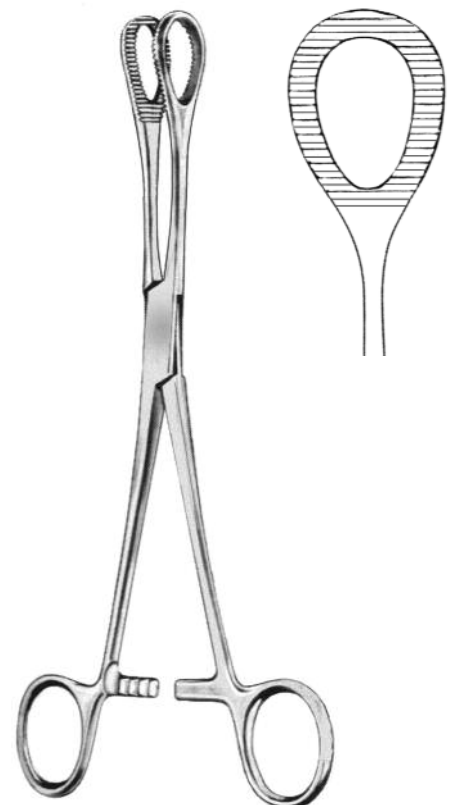

Doyen
21,5 cm 05-730-22



25,0 cm **05-732-25**



26,0 cm **05-732-26**

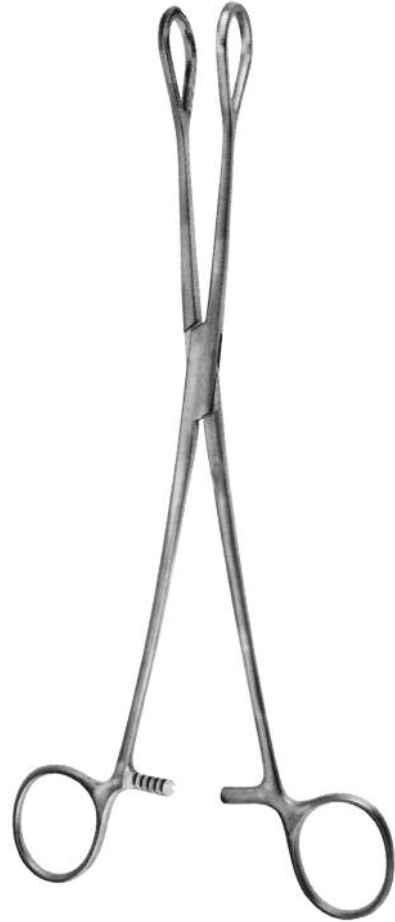

Polypen Atrauma Fasszange
 Atrauma Tissue Grasping Forceps

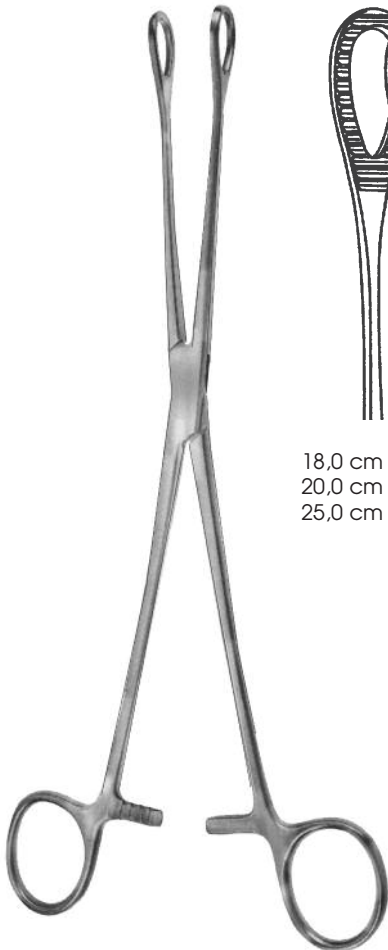

Förster-Ballenger Fasszange
 Grasping Forceps

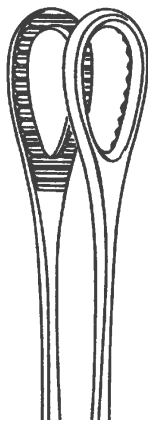

18,0 cm **05-736-18**
 20,0 cm **05-736-20**
 25,0 cm **05-736-25**

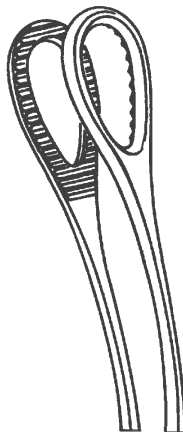

18,0 cm **05-737-18**
 20,0 cm **05-737-20**
 25,0 cm **05-737-25**

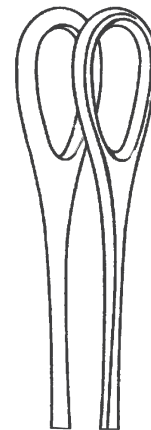

18,0 cm **05-738-18**
 20,0 cm **05-738-20**
 25,0 cm **05-738-25**



18,0 cm **05-739-18**
 20,0 cm **05-739-20**
 25,0 cm **05-739-25**

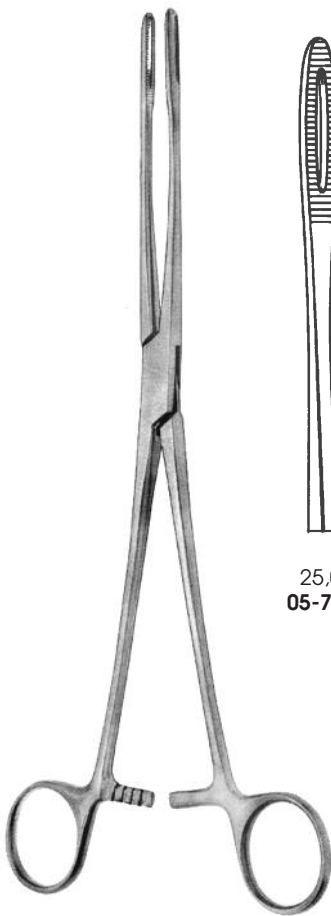

Förster



25,0 cm
05-740-25

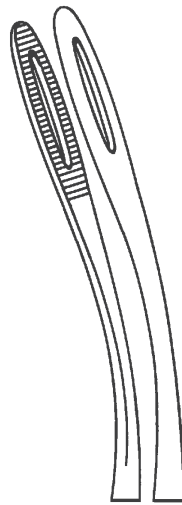

25,0 cm
05-741-25

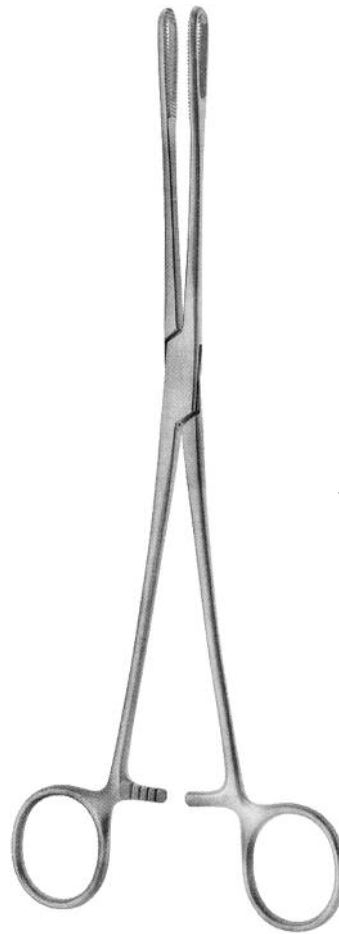

Rampley

18,0 cm 05-742-18



25,0 cm 05-742-25



Williams

16,0 cm 05-744-16



Collin

14,0 cm 05-750-14



Collin

18,0 cm 05-750-18
20,0 cm 05-750-20

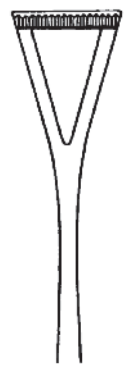



Collin, Atrauma



19,5 cm **05-751-19**

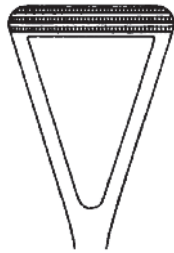

23,0 cm **05-751-23**



Duval

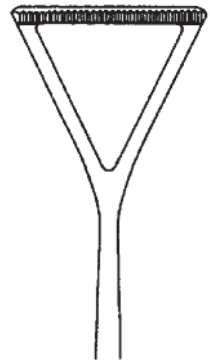

20,0 cm **05-752-20**
 23,0 cm **05-752-23**

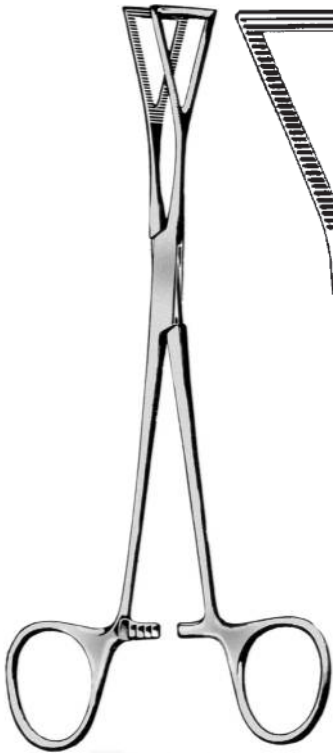

Lovelace
 20,0 cm **05-754-20**



Lovelace
 20,0 cm **05-755-20**



Pennington



15,0 cm
05-756-15



20,0 cm
05-756-20

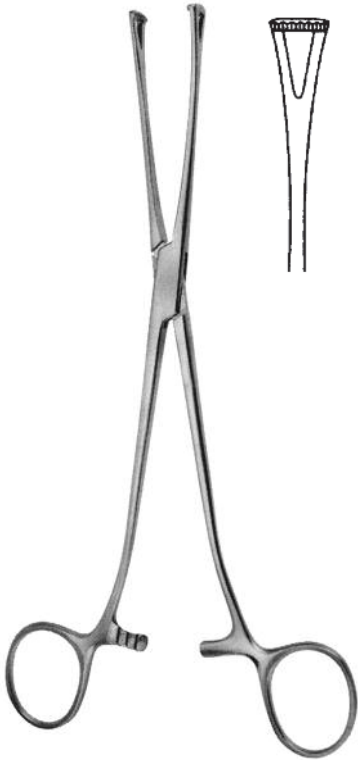

Lockwood
20,0 cm **05-758-20**



Babcock
16,0 cm **05-760-16**
18,0 cm **05-760-18**
20,0 cm **05-760-20**
24,0 cm **05-760-24**

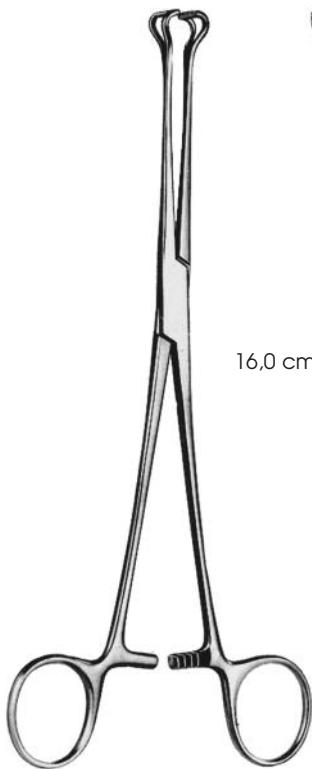

Babcock, Atrauma

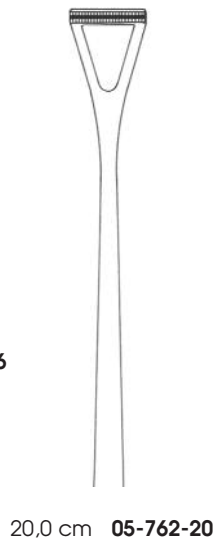
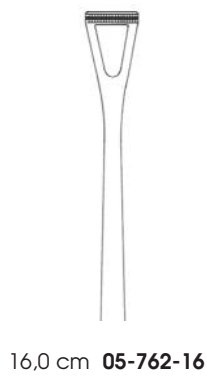

Babcock TC





Baby-Allis,
 12,0 cm **05-766-12**



Allis
 14,0 cm **05-766-14**



Allis
 15,0 cm **05-766-15**
 19,0 cm **05-766-19**
 25,0 cm **05-766-25**

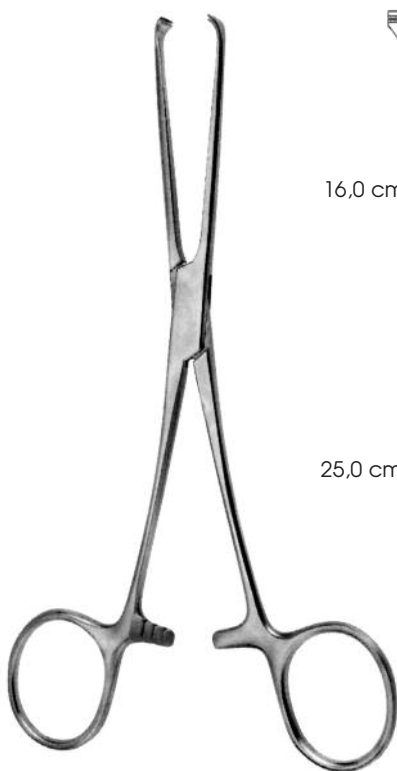

Allis Atrauma

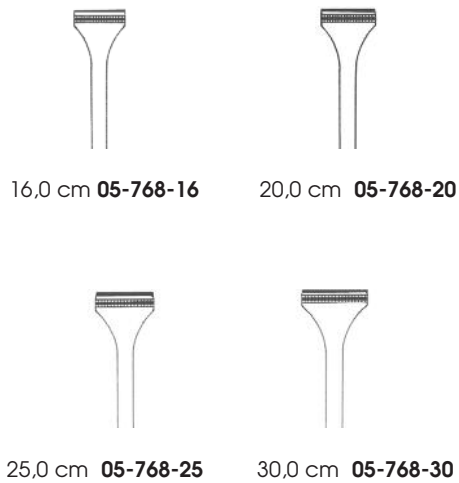

Allis-Thoms



Allis
20,0 cm 05-771-20



Judd-Allis
15,0 cm 05-772-15
19,0 cm 05-772-19



Boys-Allis
15,0 cm 05-774-15



Allis-Adair
15,0 cm 05-776-15



Tuffier
13,0 cm 05-778-13



Chaput
13,0 cm 05-780-13

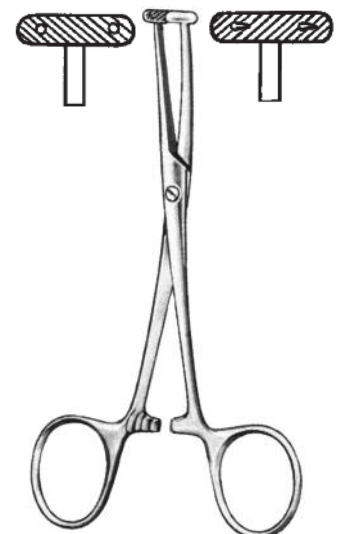

Martel
14,0 cm 05-786-14



Backhaus
 8,0 cm **05-801-08**
 11,0 cm **05-801-11**
 13,0 cm **05-801-13**
 15,0 cm **05-801-15**

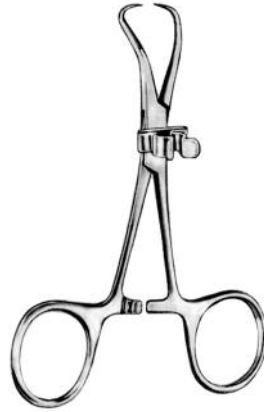

Backhaus
 11,0 cm **05-803-11**



Backhaus
 11,0 cm **05-804-11**
 13,0 cm **05-804-13**



Tuchklemme
 Towel Forceps
 11,0 cm **05-805-11**
 14,0 cm **05-805-14**



Bernhard
 16,0 cm **05-807-16**

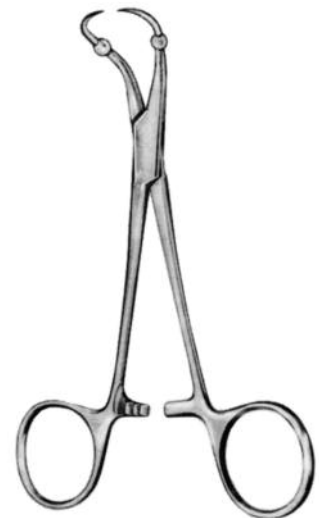

Roeder
 13,0 cm **05-809-13**
 15,0 cm **05-809-15**



Lane
13,0 cm **05-811-13**
15,0 cm **05-811-15**
20,0 cm **05-811-20**



Schädel



Jones
9,0 cm **05-819-09**



Jones
9,0 cm **05-820-09**

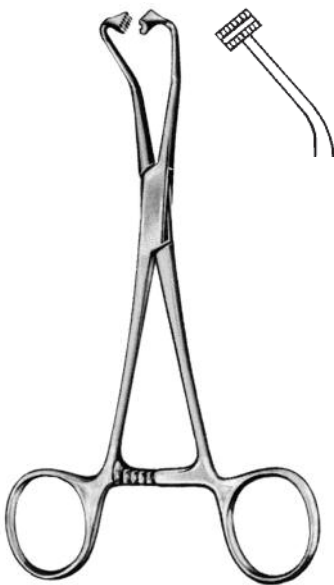

Bertram
14,0 cm **05-821-14**

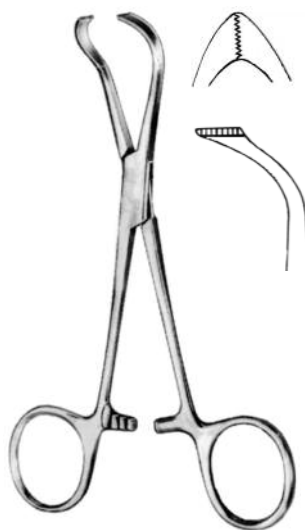

Lorna
10,0 cm **05-823-10**
13,0 cm **05-823-13**



Tohoku
10,0 cm **05-825-10**
13,0 cm **05-825-13**



16,0 cm **05-840-16**
 18,0 cm **05-840-18**
 20,0 cm **05-840-20**

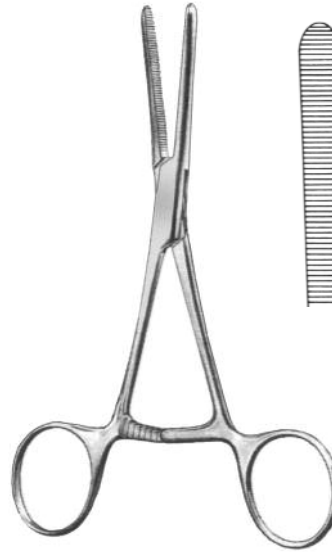

14,0 cm **05-842-14**
 16,0 cm **05-842-16**
 20,0 cm **05-842-20**



15,0 cm
05-844-15



18,0 cm
05-844-18



20,0 cm
05-844-20



15,0 cm
05-846-15



18,0 cm
05-846-18



20,0 cm
05-846-20

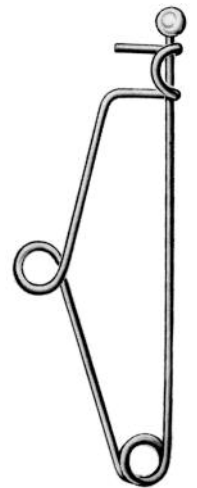

13,0 cm
05-851-13